

R32 RESIDENTIAL & LIGHT COMMERCIAL AIR CONDITIONING 2019 / 2020

AIR IS LIFE

AIR IS COMFORT

AIR IS ENERGY

QUALITY AIR FOR LIFE



- Please read the Installation Instructions carefully before installing the unit, and the Operating Instructions before using it.
- Specifications are subject to change without prior notice.
- The contents of this catalogue are accurate as of April 2019.
- Due to printing considerations, the actual colours may vary slightly from those shown.
- All graphics are provided merely for the purpose of illustrating a point.

Authorised Dealer

 Do not add or replace refrigerant other than the specified type. Manufacturer is not responsible for the damage and deterioration in safety due to usage of other refrigerant.

19PAC0401

Panasonic Australia Pty. Limited.

Address: 1 Innovation Road, Macquarie Park, NSW 2113
ACN 001 592 187 ABN 83 001 592 187

aircon.panasonic.com.au



Panasonic
Air Conditioning



QUALITY AIR FOR LIFE

Space Saving and Energy Saving Solutions



CONTENTS

Product Line-up	4 - 5
Outdoor Unit	6 - 11
Splittable Ducted	12 - 13
Indoor Unit	
High Static Pressure Ducted	14 - 17
High Static Pressure Splittable Ducted	18 - 19
High Static Pressure Slim-line Ducted	20 - 23
4-WAY Cassette	24 - 29
Under Ceiling	30 - 33
Wall Mounted	34 - 35
Dimensions	36 - 39
Products for Small Sized Project	40 - 45
Smart Control Management Solutions	
Panasonic Comfort Cloud	48 - 49
Home Automation	50 - 51
PAC Smart Connectivity+	52 - 59
Panasonic AC Smart Cloud	60 - 61
Controllers	62 - 70

All side discharge R32 outdoor units P. 6 - 11



The newly engineered R32 Compact & Deluxe ranges feature a combination of large fan bodies with a side discharge to maximize installation flexibility.

Easy to install splittable ducted P. 12 - 13



The new High Static Pressure design splits the unit into three components for installation flexibility.



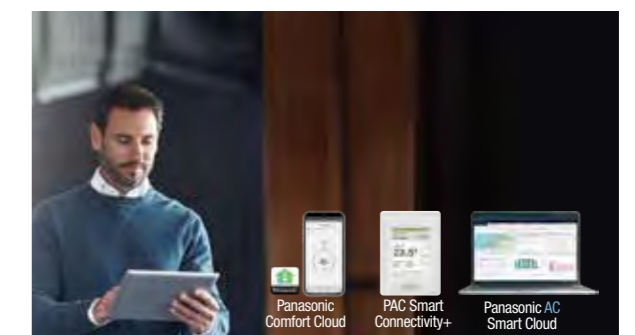













































Panasonic Smart Connectivity & Controls P. 46 - 59

















Explore a range of connected control solutions suited perfectly to your system needs.

Product Line-up

For Medium Sized Project

		Cooling Capacity	6.0 kW	7.1 kW	10.0 kW	12.5 kW	14.0 kW	16.0 kW	18.0 kW	20.0 kW	22.4 kW	
Indoor Unit	Ducted High Static Pressure Model Page 14-17 for 6.0kW - 16.0kW  ECONAVI ready		S-60PE1R5B 	S-71PE1R5B 	S-100PE1R5B 	S-125PE1R5B 	S-140PE1R5B 	S-160PE1R5B NEW 				
	Splittable Ducted High Static Pressure Model Page 18-19 for 18kW - 22.4kW									S-180PE3R5B NEW 	S-200PE3R5B NEW 	S-224PE3R5B NEW 
	Slim-line Ducted High Static Pressure Model Page 20-23  ECONAVI ready		S-60PF1E5B 	S-71PF1E5B 	S-100PF1E5B 	S-125PF1E5B 	S-140PF1E5B 					
	4-WAY Cassette * Panel is provided as an option (CZ-KPU3H/CZ-KPU3A) Page 24-29  nanoe X ready  ECONAVI ready		S-60PU2E5B 	S-71PU2E5B 	S-100PU2E5B 	S-125PU2E5B 	S-140PU2E5B 					
	Under Ceiling Page 30-33  ECONAVI ready		S-60PT2E5B 	S-71PT2E5B 	S-100PT2E5B 	S-125PT2E5B 	S-140PT2E5B 					
	Wall Mounted Page 34-35  ECONAVI ready							S-100PK2E5B 				
Outdoor Unit	R32 Deluxe Model Page 6-11  R32 REFRIGERANT  DRED ready			U-71PZH2R5 NEW 	U-100PZH2R5 NEW 	U-125PZH2R5 NEW 	U-140PZH2R5 NEW 	U-160PZH2R5 NEW 	U-180PZH2R8* NEW 	U-200PZH2R8* NEW 	U-224PZH2R8* NEW 	* 3 phase
	R32 Compact Model Page 6-11  R32 REFRIGERANT  DRED ready			U-60PZ2R5 	U-71PZ2R5 	U-100PZ2R5 	U-125PZ2R5 	U-140PZ2R5 				

For Small Sized Project

		Cooling Capacity	2.5/2.6 kW	3.5/3.7 kW	4.8/5.0 kW	5.6/5.7 kW
Indoor Unit	Ultra Slim Ducted Page 40-45		CS-Z25UD3RAW NEW 	CS-Z35UD3RAW NEW 	CS-Z50UD3RAW NEW 	CS-Z60UD3RAW NEW 
	Mini Cassette Page 40-45		CS-Z25UB4RAW NEW 	CS-Z35UB4RAW NEW 	CS-Z50UB4RAW NEW 	CS-Z60UB4RAW NEW 
Outdoor Unit	R32 Model  R32 REFRIGERANT  DRED ready		CU-Z25UBRA NEW 	CU-Z35UBRA NEW 	CU-Z50UBRA NEW 	CU-Z60UBRA NEW 

NEW

All side discharge R32 outdoor units

Panasonic's new range of outdoor units feature intuitive technology and thoughtful engineering. The two innovative ranges of R32 units, both Deluxe and Compact, feature energy and space saving technologies, permitting installation in even the tightest and demanding conditions.



More Efficient, Less Space

Whilst maintaining its strong power, new R32 outdoor units get smaller. This enables them to fit into tighter spaces. Thus you can install these units in a vast variety of areas.

All side discharge from 6.0kw to 22.4kW



Industry-leading Small Body with All 1-fan Models



Next Generation Refrigerant: R32

R32, an innovative refrigerant in all ways imaginable: it is easy to install, and compared to most other refrigerants it has a much lower environmental impact and saves energy.

R32 Deluxe

R32 Compact

- Low Global Warming Potential (GWP): 75% less impact on global warming vs R410A
- Energy Efficient: Higher energy efficiency than R410A
- Easy Installation: This refrigerant is 100% pure which makes it easier to recycle and reuse.

Energy Saving Technology

R32 Deluxe

The use of energy saving design for the structure of fans, fan motors, compressors and heat exchangers results in high EER and COP value, which ranks as one of the top in the industry.

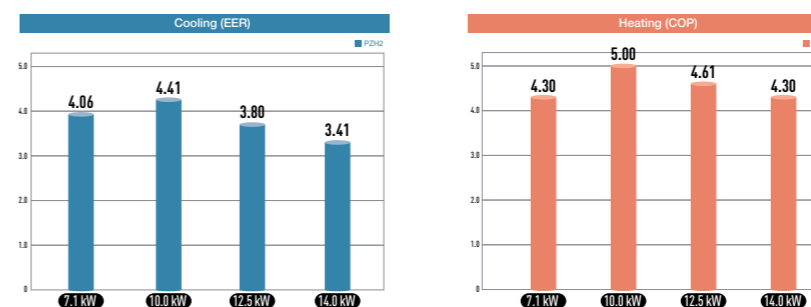

* The graph shows 4-WAY Cassette R32 Deluxe models values.

Precise Temperature Control

Constant Comfort Air Conditioning

R32 Deluxe

R32 Compact

Another advantage of Panasonic Premium Inverter technology includes its ability to ensure precise temperature control and offer a wider power output range to perform in even the most extreme conditions in Australia, ensuring constant comfort.

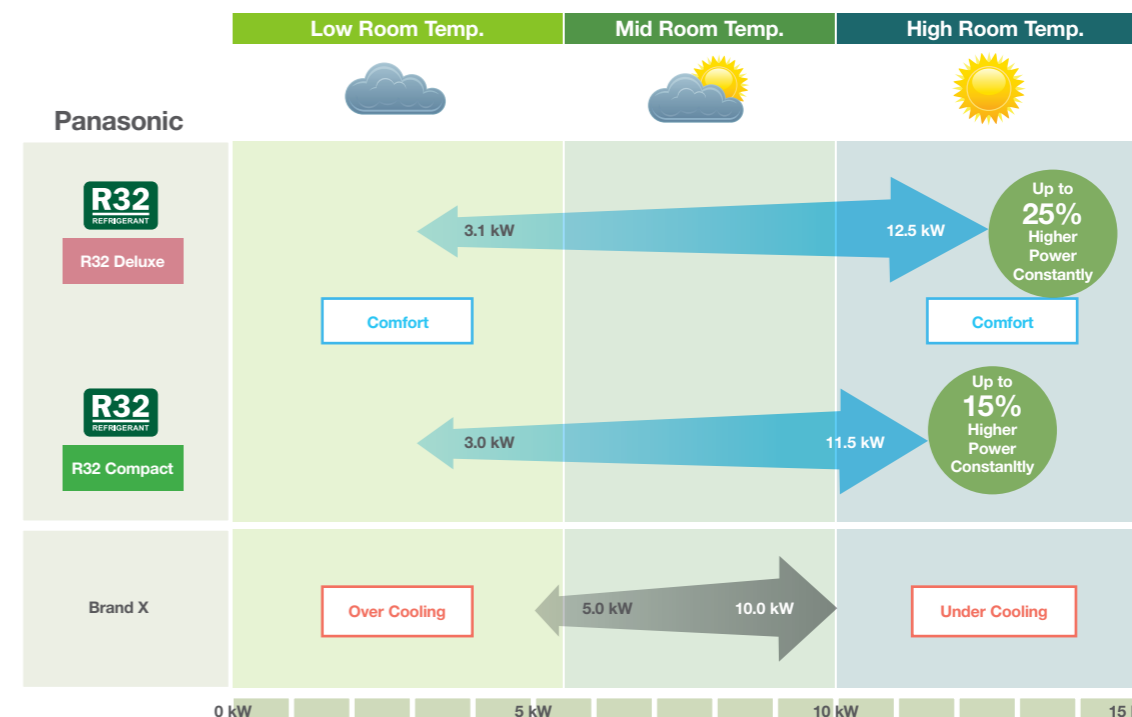

Outdoor Unit

Other Advanced Technology

Increased Piping Length for Greater Design Flexibility

R32 Deluxe

Adaptable to various building types and sizes
 Max. piping length :
 50m (7.1kW),
 85m (10.0kW-14.0kW),
 75m (16.0kW, 18.0kW)
 60m (20.0kW, 22.4kW)

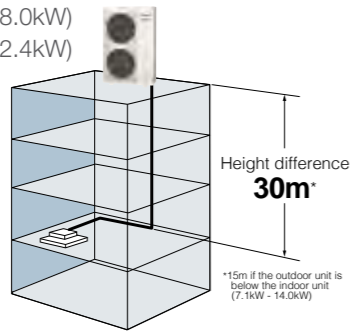

Product Quality and Safety

R32 Compact R32 Deluxe

All Panasonic air conditioners undergo strict quality and safety tests before sale. This rigorous process includes obtaining all necessary Safety Approvals, to ensure that all air conditioners we sell are not only built to the highest market standards, but are also completely safe.



Quiet Mode

R32 Compact R32 Deluxe

Quiet mode reduces outdoor operating sound by 2dB. External input signal is also available.

Demand Response Compliant

R32 Compact R32 Deluxe

Panasonic air conditioners are equipped with a Demand Response Enabling Device (DRED) which complies to both AS 4755 and AS 3823. Panasonic continues to design and develop products that are tailored to local needs and requirements.

The Equipment Energy Efficiency (E3) program has been supporting the development of DRED standards for air-conditioners which should comply with AS 4755. The functionality will be required for all installations in the very near future

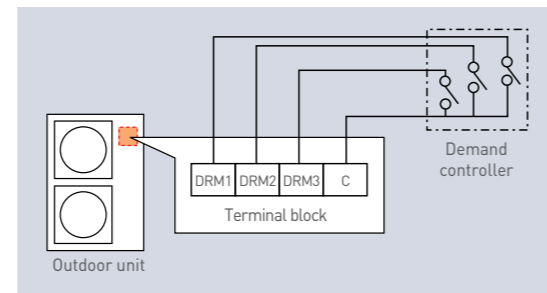

Demand control terminal is available to control 0-50-75-100% of capacities.

Outdoor Unit Dimensions

R32 Compact Model Dimensions (6.0kW – 7.1kW)

U-60PZ2R5 / U-71PZ2R5

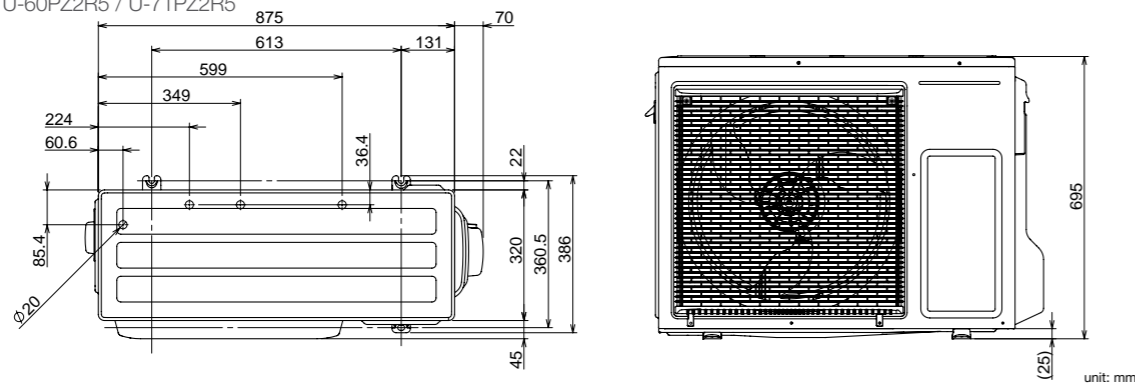

R32 Compact Model Dimensions (10.0kW – 14.0kW)

U-100PZ2R5 / U-100PZ2R8 / U-125PZ2R5 / U-125PZ2R8 / U-140PZ2R5 / U-140PZ2R8

- 1) Mounting hole (4-R6.5), anchor bolt : M10
- 2) Refrigerant tubing (liquid tube), flared connection (Ø9.52)
- 3) Refrigerant tubing (gas tube), flared connection (Ø15.88)
- 4) Refrigerant tubing port
- 5) Electrical wiring port (ø13)
- 6) Electrical wiring port (ø22)
- 7) Electrical wiring port (ø27)
- 8) Electrical wiring port (ø35)

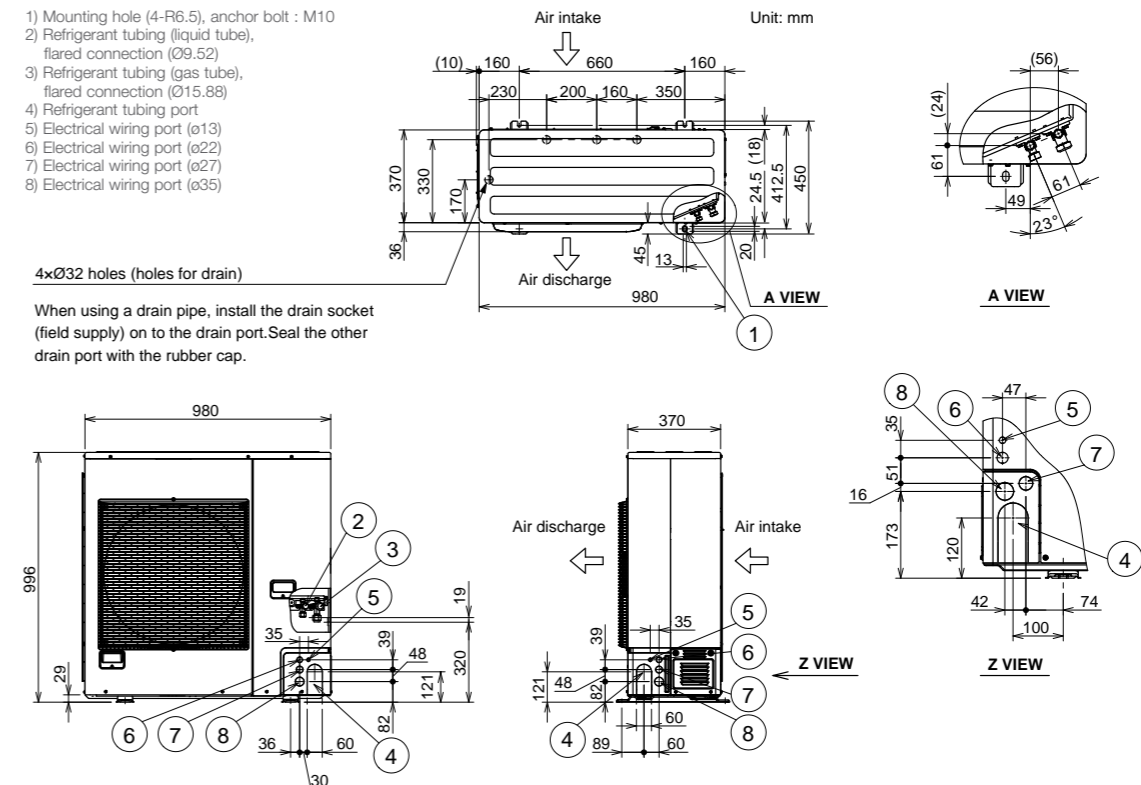

R32 Deluxe Model Dimensions (7.1kW)

U-71PZH2R5

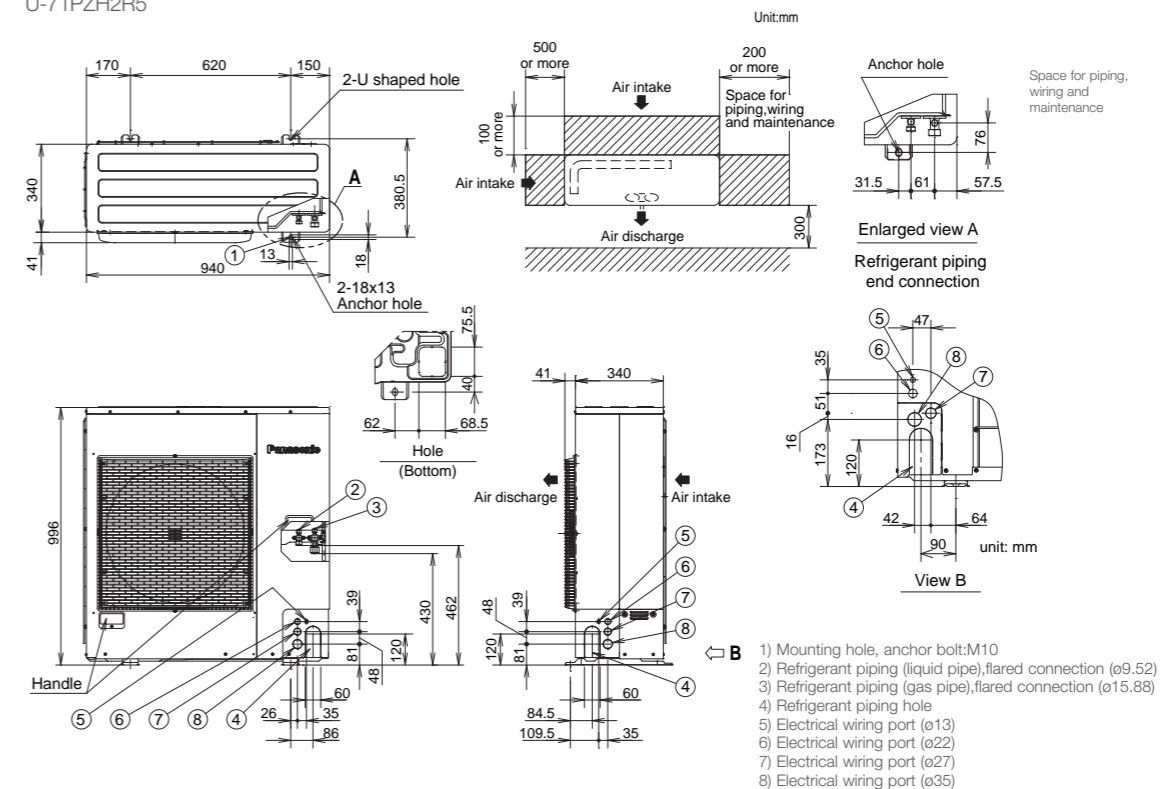

Outdoor Unit

R32 Deluxe Model Dimensions (10.0kW – 14.0kW)

U-100PZH2R5 / U-100PZH2R8 / U-125PZH2R5 / U-125PZH2R8 / U-140PZH2R5 / U-140PZH2R8

- ① Mounting hole, anchor bolt:M10
- ② Refrigerant piping(liquid pipe),flared connection (ø9.52)
- ③ Refrigerant piping(gas pipe),flared connection (ø15.88)
- ④ Refrigerant piping hole
- ⑤ Electrical wiring port (ø13)
- ⑥ Electrical wiring port (ø22)
- ⑦ Electrical wiring port (ø27)
- ⑧ Electrical wiring port (ø35)

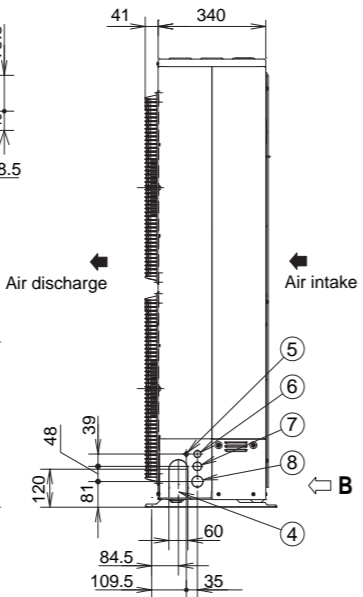
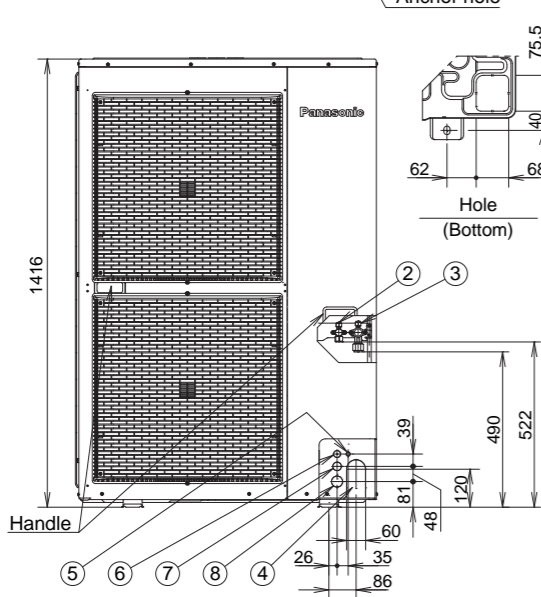
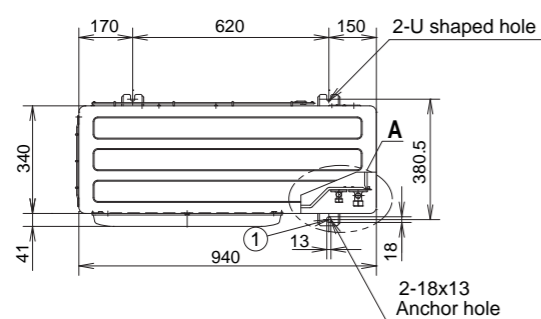

unit: mm

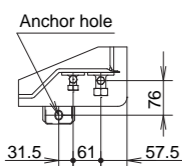

Enlarged view A
Refrigerant piping
end connection

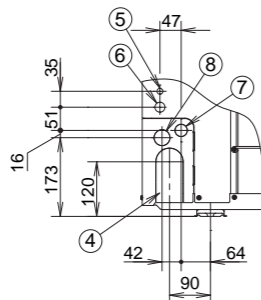

Enlarged view B

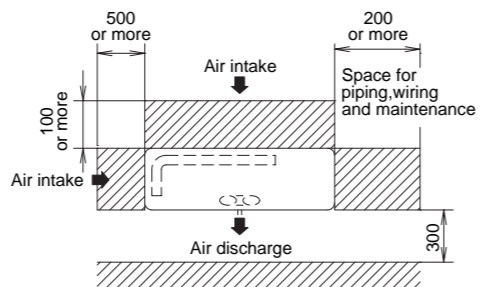

R32 Deluxe Model Dimensions (16.0kW – 22.4kW)

U-160PZH2R5 / U-160PZH2R8 / U-180PZH2R8 / U-200PZH2R8 / U-224PZH2R8

- ① Mounting hole (4-R6.5), anchor bolt : M10
- ② Refrigerant tubing (liquid tube), flared connection (160/180 : ø9.52, 200/224 : ø12.7)
- ③ Refrigerant tubing (gas tube), flared connection (ø19.05)*1
- ④ Refrigerant tubing port
- ⑤ Electrical wiring port (ø13)
- ⑥ Electrical wiring port (ø22)
- ⑦ Electrical wiring port (ø27)
- ⑧ Electrical wiring port (ø35)

Specification for pipe connecting indoor unit to outdoor unit.

*1 (Gas tubing connection) While the main gas tube is ø25.4, since connecting the outdoor unit's 3-way valve requires a ø19.05 flare, please be sure to use reducer (field supply) for connection (brazing).

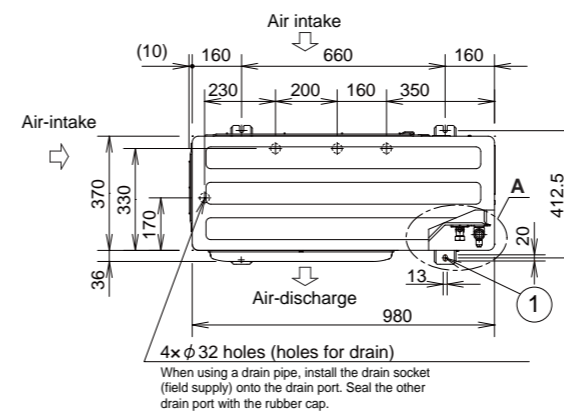

When using a drain pipe, install the drain socket (field supply) onto the drain port. Seal the other drain port with the rubber cap.

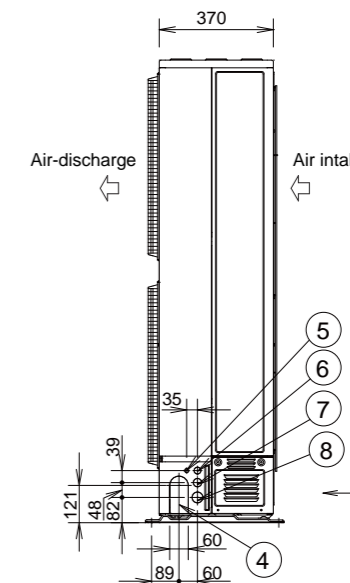
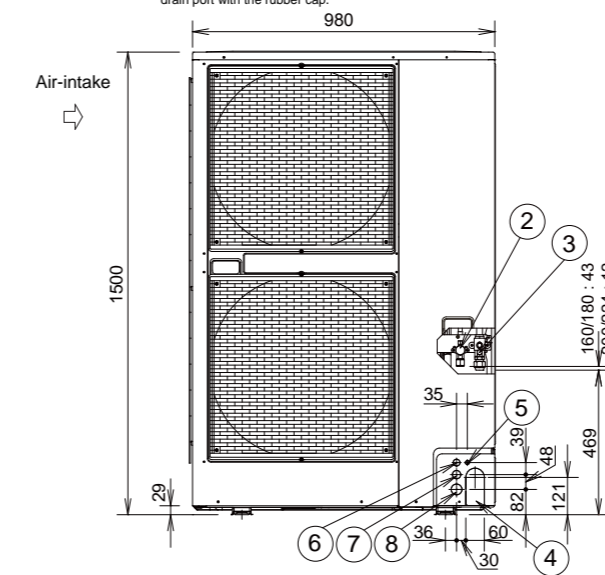

unit: mm

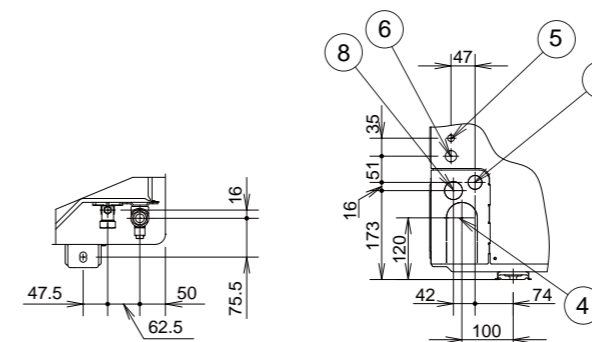

Enlarged view A

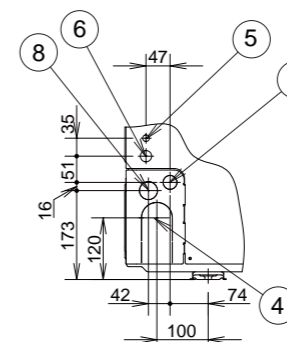

Enlarged view B

Easy to install splittable ducted

Create comfort faster. The newly designed high static pressure ducted model is improved for a more flexible installation. By dividing the unit into 3 components, the burden of installation is reduced.

*In the case of the S-180PE3R5B, S-200PE3R5B, and S-224PE3R5B



Easy Installation Design

3 Components For Easy In-Ceiling Assembly

The newly designed high static pressure ducted consists of 3 components, the heat exchanger, the fan and the fan casing. For easy installation, the unit has been designed to be lifted into the roof via return air grille, separated, and easily reassembled when in position.

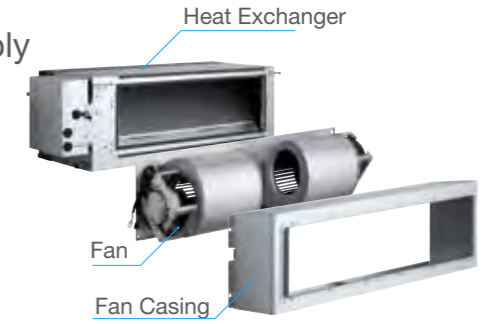

New Ducted Model Key Factors

Bell Shaped Keyhole for Weight Support

Part of the keyhole is newly designed with a bell shape to reduce the burden of installation. It also enables temporary attachment.



2 Wire Connectors for Easy Installation

With only 2 wire connectors, installation has become much easier and faster.

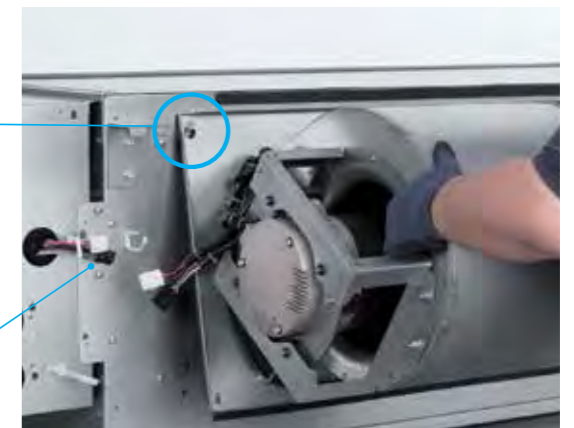

12 Bolts & Screws for Easy Assembly

Only 12 screws and bolts need to be attached, allowing for a shorter installation time.

Even cooling for all rooms

Top Grade of Airflow Volume

Providing powerful air, Panasonic's splittable ducted has increased the rate of airflow by 16%, reaching up to 1,400 l/s. Its powerful airflow enables faster room temperature control.



* Comparison between S-224PE3R5B and S-224PE2R5B



3-step Static Pressure Set Up

You can select between the three Static Pressure modes of 200 Pa / 130 Pa / 75 Pa for extra installation flexibility.



* In case of S-224PE3R5B

Max.200 Pa Static Pressure Setting

A maximum static pressure setting of a powerful 200Pa enables the use of long ducts for installation in a wide range of spaces. Ideal for large-scale houses, offices and restaurants.

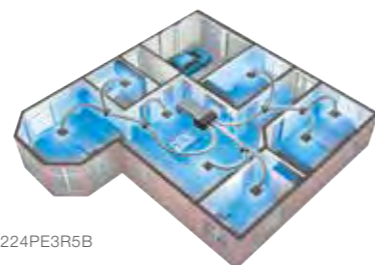

* In case of S-224PE3R5B

Easy Assembly Steps

Assembly takes three easy steps, even in limited spaces.



- 1 Install the fan to the heat exchanger and tighten the screws and bolts.
- 2 Assemble the connectors.
- 3 Install the chassis and tighten the screws and bolts.



Indoor Unit High Static Pressure Ducted

High static and large airflow ducted for exceptional installation flexibility.

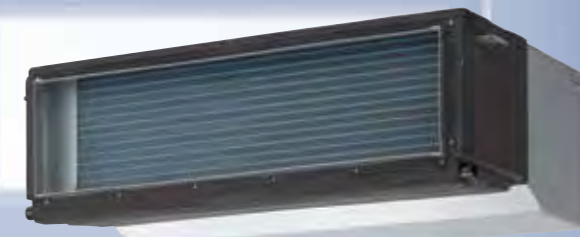

S-60PE1R5B
S-71PE1R5B
S-100PE1R5B

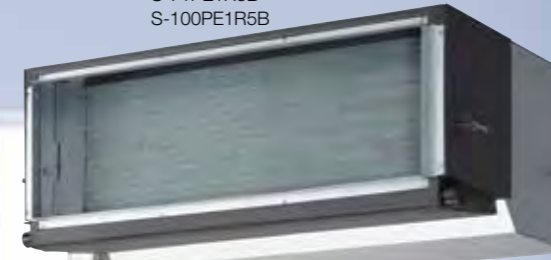

S-125PE1R5B
S-140PE1R5B
S-160PE1R5B



Compact Body Size

Hidden in the ceiling, ideal when interior decor is an important consideration such as in residences with many rooms and light commercial buildings.

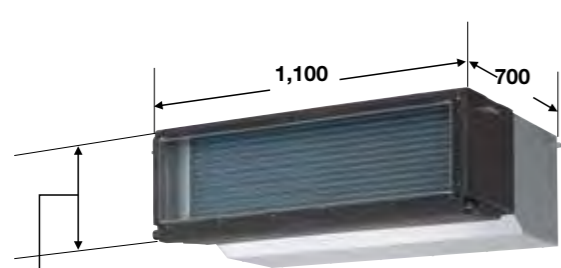

290mm (S-60PE1R5B)
360mm (S-71PE1R5B,
S-100PE1R5B)

S-60PE1R5B
S-71PE1R5B
S-100PE1R5B

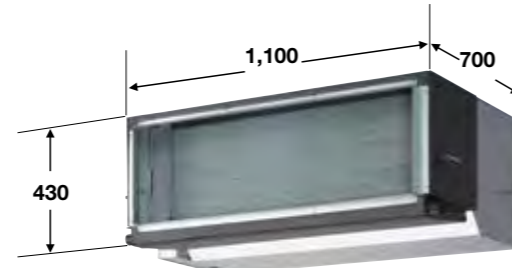

S-125PE1R5B
S-140PE1R5B
S-160PE1R5B

System Example

An inspection port (450 mm x 450 mm or more) is required at the control-box side of the indoor unit body.

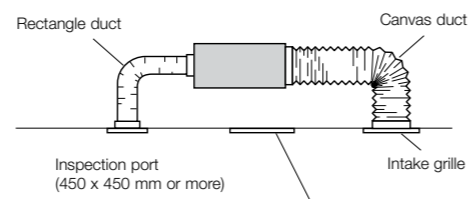

Cold Drafts Reduced During Heating Operation

- Accurate temperature measurement by E1/E2 sensor to reduce cold drafts during heating operation.

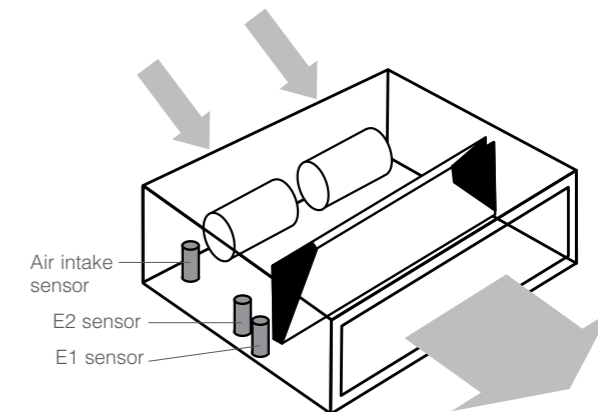

Indoor Unit: High Static Pressure Ducted

Specifications of R32 Deluxe Model R32 REFRIGERANT

Capacity		7.1kW	10.0kW	12.5kW	14.0kW	16.0kW					
Model Name	Indoor Unit	S-71PE1R5B	S-100PE1R5B	S-100PE1R5B	S-125PE1R5B	S-140PE1R5B	S-140PE1R5B	S-160PE1R5B	S-160PE1R5B		
	Outdoor Unit	U-71PZH2R5	U-100PZH2R5	U-100PZH2R8	U-125PZH2R5	U-125PZH2R8	U-140PZH2R5	U-140PZH2R8	U-160PZH2R5	U-160PZH2R8	
Cooling capacity : Heating capacity	kW	7.1 (2.2 - 9.0) 8.0 (2.0 - 9.0)	10.0 (3.1 - 12.5) 11.2 (3.1 - 14.0)	10.0 (3.1 - 12.5) 11.2 (3.1 - 14.0)	12.5 (3.2 - 14.0) 14.0 (3.2 - 16.0)	12.5 (3.2 - 14.0) 14.0 (3.2 - 16.0)	14.0 (3.3 - 16.0) 16.0 (3.3 - 18.0)	14.0 (3.3 - 16.0) 16.0 (3.3 - 18.0)	16.0 (5.5 - 18.0) 18.0 (5.5 - 20.0)	16.0 (5.5 - 18.0) 18.0 (5.5 - 20.0)	
	BTU/h	24,200 (7,500 - 30,700) 27,300 (6,800 - 30,700)	34,100 (10,600 - 42,700) 38,200 (10,600 - 47,800)	34,100 (10,600 - 42,700) 38,200 (10,600 - 47,800)	42,700 (10,900 - 47,800) 47,800 (10,900 - 54,600)	42,700 (10,900 - 47,800) 47,800 (10,900 - 54,600)	47,800 (11,300 - 54,600) 54,600 (11,300 - 61,400)	47,800 (11,300 - 54,600) 54,600 (11,300 - 61,400)	54,600 (18,800 - 61,400) 61,400 (18,800 - 68,200)	54,600 (18,800 - 61,400) 61,400 (18,800 - 68,200)	
EER : COP	W/W	3.38 : 3.83	3.64 : 3.65	3.64 : 3.65	3.42 : 3.71	3.42 : 3.71	3.18 : 3.64	3.18 : 3.64	3.26 : 3.50	3.26 : 3.56	
Total power input	Cooling : Heating	kW	2.10 : 2.09	2.75 : 3.07	2.75 : 3.07	3.65 : 3.77	3.65 : 3.77	4.40 : 4.40	4.40 : 4.40	4.91 : 5.05	4.91 : 5.05
Indoor Unit											
Power source	Phase/Hz	1 Phase/ 50Hz	1 Phase/ 50Hz	1 Phase/ 50Hz	1 Phase/ 50Hz	1 Phase/ 50Hz	1 Phase/ 50Hz	1 Phase/ 50Hz	1 Phase/ 50Hz	1 Phase/ 50Hz	
	V	230V 240V	230V 240V	230V 240V	230V 240V	230V 240V	230V 240V	230V 240V	230V 240V	230V 240V	
Current	Cooling : Heating	A	1.24 : 1.24 1.25 : 1.25	1.72 : 1.72 1.74 : 1.74	1.72 : 1.72 1.74 : 1.74	1.82 : 1.82 1.84 : 1.84	1.82 : 1.82 1.84 : 1.84	2.62 : 2.62 2.70 : 2.70	2.62 : 2.62 2.70 : 2.70	2.62 : 2.62 2.70 : 2.70	2.62 : 2.62 2.70 : 2.70
Dimensions	H x W x D	mm	360x1,100 (+100)x700	360x1,100 (+100)x700	360x1,100 (+100)x700	430x1,100 (+100)x700	430x1,100 (+100)x700	430x1,100 (+100)x700	430x1,100 (+100)x700	430x1,100 (+100)x700	430x1,100 (+100)x700
Net weight		kg	42	44	44	48	48	53	53	53	53
Air volume	Cooling : Heating	L/s	500 : 500	666 : 666	666 : 666	833 : 833	833 : 833	1,000 : 1,000	1,000 : 1,000	1,000 : 1,000	1,000 : 1,000
External static pressure		Pa	100 (Max.150)	100 (Max.150)	100 (Max.150)	100 (Max.150)	100 (Max.150)	100 (Max.150)	100 (Max.150)	100 (Max.150)	100 (Max.150)
Sound pressure level (H/M/L)	Cooling : Heating	dB(A)	45 / 44 / 43 : 45 / 44 / 43	48 / 46 / 44 : 48 / 46 / 44	48 / 46 / 44 : 48 / 46 / 44	49 / 47 / 45 : 49 / 47 / 45	49 / 47 / 45 : 49 / 47 / 45	51 / 49 / 47 : 51 / 49 / 47	51 / 49 / 47 : 51 / 49 / 47	51 / 49 / 47 : 51 / 49 / 47	51 / 49 / 47 : 51 / 49 / 47
Sound power level (H/M/L)	Cooling : Heating	dB(A)	62 / 61 / 60 : 62 / 61 / 60	70 / 68 / 66 : 70 / 68 / 66	70 / 68 / 66 : 70 / 68 / 66	71 / 69 / 67 : 71 / 69 / 67	71 / 69 / 67 : 71 / 69 / 67	73 / 71 / 69 : 73 / 71 / 69	73 / 71 / 69 : 73 / 71 / 69	73 / 71 / 69 : 73 / 71 / 69	73 / 71 / 69 : 73 / 71 / 69
Number of fan speeds			3	3	3	3	3	3	3	3	
Drain pipe size		mm	VP-25	VP-25	VP-25	VP-25	VP-25	VP-25	VP-25	VP-25	VP-25
Outdoor Unit											
Power source	Phase/Hz	1 Phase/ 50Hz	1 Phase/ 50Hz	3 Phase/ 50Hz	1 Phase/ 50Hz	3 Phase/ 50Hz	1 Phase/ 50Hz	3 Phase/ 50Hz	1 Phase/ 50Hz	3 Phase/ 50Hz	
	V	230V 240V	230V 240V	400V 415V	230V 240V	400V 415V	230V 240V	400V 415V	230V 240V	400V 415V	
Current	Cooling : Heating	A	8.45 : 8.20 8.00 : 7.90	10.8 : 12.2 10.20 : 11.6	3.60 : 4.10 3.45 : 3.95	14.8 : 15.4 14.1 : 14.6	5.00 : 5.15 4.75 : 4.95	17.4 : 17.4 16.5 : 16.5	5.85 : 5.85 5.55 : 5.55	20.0 : 21.1 18.9 : 20.0	6.95 : 7.15 6.60 : 6.80
Dimensions	H x W x D	mm	996 x 940 x 340	1,416 x 940 x 340	1,416 x 940 x 340	1,416 x 940 x 340	1,416 x 940 x 340	1,416 x 940 x 340	1,416 x 940 x 340	1,500 x 980 x 370	1,500 x 980 x 370
Net weight		kg	68	99	99	99	99	99	99	115	115
Air volume	Cooling : Heating	L/s	1,017 : 1,000	1,967 : 1,800	1,967 : 1,800	2,083 : 1,867	2,083 : 1,867	2,150 : 1,933	2,150 : 1,933	2,733	2,733
Sound pressure level (Silent mode)	Cooling : Heating	dB(A)	48 (46) : 50 (48)	52 (50) : 52 (50)	52 (50) : 52 (50)	53 (51) : 53 (51)	53 (51) : 53 (51)	54 (52) : 54 (52)	54 (52) : 54 (52)	58 (56) : 60 (58)	58 (56) : 60 (58)
Sound power level (Silent mode)	Cooling : Heating	dB(A)	64 (62) : 66 (64)	68 (66) : 68 (66)	68 (66) : 68 (66)	69 (67) : 69 (67)	69 (67) : 69 (67)	70 (68) : 70 (68)	70 (68) : 70 (68)	76 (74) : 78 (76)	76 (74) : 78 (76)
Piping connections	Liquid / Gas	mm	Ø9.52 / Ø15.88	Ø9.52 / Ø15.88	Ø9.52 / Ø15.88	Ø9.52 / Ø15.88	Ø9.52 / Ø15.88	Ø9.52 / Ø15.88	Ø9.52 / Ø15.88	Ø9.52 / Ø19.05	Ø9.52 / Ø19.05
Pipe length	min. - max.	m	5 - 50	5 - 85	5 - 85	5 - 85	5 - 85	5 - 85	5 - 85	5 - 75	5 - 75
Elevation difference (OU located lower, OU located higher)		m	15, 30	15, 30	15, 30	15, 30	15, 30	15, 30	15, 30	30, 30	30, 30
Maximum chargeless length		m	30	30	30	30	30	30	30	30	30
Refrigerant at shipping / Additional gas amount		g	R32 1,950 / 45 (g/m)	R32 3,050 / 45 (g/m)	R32 3,050 / 45 (g/m)	R32 3,050 / 45 (g/m)	R32 3,050 / 45 (g/m)	R32 3,050 / 45 (g/m)	R32 3,050 / 45 (g/m)	R32 3,200 / 45 (g/m)	R32 3,200 / 45 (g/m)
Operation ranges	Cooling : Heating	°C	-15 to 46 : -20 to 24	-15 to 46 : -20 to 24	-15 to 46 : -20 to 24	-15 to 46 : -20 to 24	-15 to 46 : -20 to 24	-15 to 46 : -20 to 24	-15 to 46 : -20 to 24	-15 to 46 : -20 to 24	-15 to 46 : -20 to 24

Specifications of R32 Compact Model R32 REFRIGERANT

Capacity		6.0kW	7.1kW	10.0kW	12.5kW	14.0kW				
Model Name	Indoor Unit	S-60PE1R5B	S-71PE1R5B	S-100PE1R5B	S-100PE1R5B	S-125PE1R5B	S-125PE1R5B	S-140PE1R5B	S-140PE1R5B	
	Outdoor Unit	U-60PZ2R5	U-71PZ2R5	U-100PZ2R5	U-100PZ2R8	U-125PZ2R5	U-125PZ2R8	U-140PZ2R5	U-140PZ2R8	
Cooling capacity : Heating capacity	kW	6.0 (2.0 - 7.1) 6.0 (1.8 - 7.6)	7.1 (2.0 - 8.0) 7.1 (1.8 - 8.6)	10.0 (3.0 - 11.5) 10.0 (3.0 - 14.0)	10.0 (3.0 - 11.5) 10.0 (3.0 - 14.0)	12.5 (3.2 - 13.5) 12.5 (3.3 - 15.0)	12.5 (3.2 - 13.5) 12.5 (3.3 - 15.0)	14.0 (3.3 - 15.0) 14.0 (3.4 - 16.0)	14.0 (3.3 - 15.0) 14.0 (3.4 - 16.0)	
	BTU/h	20,500 (6,800 - 24,200) 20,500 (6,100 - 25,900)	24,200 (6,800 - 27,300) 24,200 (6,100 - 29,300)	34,100 (10,200 - 39,200) 34,100 (10,200 - 47,800)	34,100 (10,200 - 39,200) 34,100 (10,200 - 47,800)	42,700 (10,900 - 46,100) 42,700 (11,300 - 51,200)	42,700 (10,900 - 46,100) 42,700 (11,300 - 51,200)	47,800 (11,300 - 51,200) 47,800 (11,600 - 54,600)	47,800 (11,300 - 51,200) 47,800 (11,600 - 54,600)	
EER : COP	W/W	3.23 : 3.92 3.23 : 3.92	3.18 : 4.06 3.18 : 4.06	3.33 : 3.89 3.44 : 3.89	3.33 : 3.89 3.44 : 3.89	3.30 : 4.00 3.30 : 4.00	3.30 : 4.00 3.30 : 4.00	3.15 : 3.66 3.15 : 3.66	3.15 : 3.66 3.15 : 3.66	
Total power input	Cooling : Heating	kW	1.86 : 1.53	2.23 : 1.75	3.00 : 2.57	3.00 : 2.57	3.79 : 3.125	3.79 : 3.125	4.44 : 3.825	4.44 : 3.825
Indoor Unit										
Power source	Phase/Hz	1 Phase/ 50Hz	1 Phase/ 50Hz	1 Phase/ 50Hz	1 Phase/ 50Hz	1 Phase/ 50Hz	1 Phase/ 50Hz	1 Phase/ 50Hz	1 Phase/ 50Hz	
	V	230V 240V	230V 240V	230V 240V	230V 240V	230V 240V	230V 240V	230V 240V	230V 240V	
Current	Cooling : Heating	A	0.85 : 0.85 0.86 : 0.86	1.24 : 1.24 1.25 : 1.25	1.72 : 1.72 1.74 : 1.74	1.72 : 1.72 1.74 : 1.74	1.82 : 1.82 1.84 : 1.84	1.82 : 1.82 1.84 : 1.84	2.62 : 2.62 2.70 : 2.70	2.62 : 2.62 2.70 : 2.70
Dimensions	H x W x D	mm	290x1,100 (+100)x700	360x1,100 (+100)x700	360x1,100 (+100)x700	360x1,100 (+100)x700	430x1,100 (+100)x700	430x1,100 (+100)x700	430x1,100 (+100)x700	430x1,100 (+100)x700
Net weight		kg	35	42	44	44	48	48	53	53
Air volume	Cooling : Heating	L/s	366 : 366	500 : 500	666 : 666	666 : 666	833 : 833	833 : 833	1,000 : 1,000	1,000 : 1,000
External static pressure		Pa	70 (Max.100)	100 (Max.150)	100 (Max.150)	100 (Max.150)	100 (Max.150)	100 (Max.150)	100 (Max.150)	100 (Max.150)
Sound pressure level (H/M/L)	Cooling : Heating	dB(A)	43 / 41 / 40 : 43 / 41 / 40	45 / 44 / 43 : 45 / 44 / 43	48 / 46 / 44 : 48 / 46 / 44	48 / 46 / 44 : 48 / 46 / 44	49 / 47 / 45 : 49 / 47 / 45	49 / 47 / 45 : 49 / 47 / 45	51 / 49 / 47 : 51 / 49 / 47	51 / 49 / 47 : 51 / 49 / 47
Sound power level (H/M/L)	Cooling : Heating	dB(A)	60 / 58 / 57 : 60 / 58 / 57	62 / 61 / 60 : 62 / 61 / 60	70 / 68 / 66 : 70 / 68 / 66	70 / 68 / 66 : 70 / 68 / 66	71 / 69 / 67 : 71 / 69 / 67	71 / 69 / 67 : 71 / 69 / 67	73 / 71 / 69 : 73 / 71 / 69	73 / 71 / 69 : 73 / 71 / 69
Number of fan speeds			3	3	3	3	3	3	3	
Drain pipe size		mm	VP-25	VP-25	VP-25	VP-25	VP-25	VP-25	VP-25	VP-25
Outdoor Unit										
Power source	Phase/Hz	1 Phase/ 50Hz	1 Phase/ 50Hz	1 Phase/ 50Hz	3 Phase/ 50Hz	1 Phase/ 50Hz	3 Phase/ 50Hz	1 Phase/ 50Hz	3 Phase/ 50Hz	
	V	230V 240V	230V 240V	230V 240V	400V 415V	230V 240V	400V 415V	230V 240V	400V 415V	
Current	Cooling : Heating	A	8.05 : 6.45 7.70 : 6.15	9.35 : 7.15 8.90 : 6.75	11.5 : 9.95 11.0 : 9.50	3.90 : 3.40 3.75 : 3.24	15.6 : 12.6 14.9 : 12.0	5.20 : 4.15 4.95 : 4.00	18.2 : 15.0 17.2 : 14.1	6.05 : 4.95 5.75 : 4.70
Dimensions	H x W x D	mm	695 x 875 x 320	695 x 875 x 320	996 x 980 x 370	996 x 980 x 370	996 x 980 x 370	996 x 980 x 370	996 x 980 x 370	996 x 980 x 370
Net weight		kg	44	44	90	90	94	94	94	94
Air volume	Cooling : Heating	L/s	750 : 750	867 : 750	1,285 : 1,169	1,285 : 1,169	1,436 : 1,302	1,436 : 1,302	1,486 : 1,386	1,486 : 1,386
Sound pressure level (Silent mode)	Cooling : Heating	dB(A)	46 (44) : 48 (46)	49 (47) : 49 (47)	52 (50) : 52 (50)	52 (50) : 52 (50)	55 (53) : 55 (53)	55 (53) : 55 (53)	56 (54) : 56 (54)	56 (54) : 56 (54)
Sound power level (Silent mode)	Cooling : Heating	dB(A)	65 (63) : 66 (64)	67 (65) : 67 (65)	68 (66) : 67 (65)	68 (66) : 67 (65)	70 (68) : 70 (68)	70 (68) : 70 (68)	71 (69) : 71 (69)	71 (69) : 71 (69)
Piping connections	Liquid / Gas	mm	Ø9.52 / Ø15.88	Ø9.52 / Ø15.88	Ø9.52 / Ø15.88	Ø9.52 / Ø15.88	Ø9.52 / Ø15.88	Ø9.52 / Ø15.88	Ø9.52 / Ø15.88	Ø9.52 / Ø15.88
Pipe length	min. - max.	m	3 - 40	3 - 40	5 - 50	5 - 50	5 - 50	5 - 50	5 - 50	5 - 50
Elevation difference (OU located lower, OU located higher)		m	15, 30	15, 30	15, 30	15, 30	15, 30	15, 30	15, 30	15, 30
Maximum chargeless length		m	30	30	30	30	30	30	30	30
Refrigerant at shipping / Additional gas amount		g	R32, 1,450 / 35 (g/m)	R32, 1,450 / 35 (g/m)	R32, 2,600 / 45 (g/m)	R32, 2,600 / 45 (g/m)	R32, 2,980 / 45 (g/m)	R32, 2,980 / 45 (g/m)	R32, 2,980 / 45 (g/m)	R32, 2,980 / 45 (g/m)
Operation ranges	Cooling : Heating	°C	-10 to 43 : -15 to 24	-10 to 43 : -15 to 24	-10 to 43 : -15 to 24	-10 to 43 : -15 to 24	-10 to 43 : -15 to 24	-10 to 43 : -15 to 24	-10 to 43 : -15 to 24	-10 to 43 : -15 to 24

Notes:
 The Rated Capacity, Power Input and Running Current are measured in accordance with AS/NZS 3823
 • Cooling: Indoor temperature: 27°C DB/ 19°C WB, Outdoor temperature: 35°C DB/ 24°C WB
 • Heating: Indoor temperature: 20°C DB/ 15°C WB, Outdoor temperature: 7°C DB/ 6°C WB

Indoor Unit

High Static Pressure

Splittable Ducted

High static and large airflow ducted for exceptional installation flexibility.



NEW



S-180PE3R5B
S-200PE3R5B
S-224PE3R5B

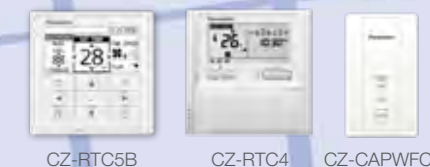

Technical focus

- Easy installation with splittable chassis design
- Max. 200Pa static pressure setting*
- Design flexibility thanks to high static pressure and large air volume
- DC motor equipped
- Low power input
- Accurate temperature control to reduce cold drafts during operation
- Configurable air temperature control

* In case of S-224PE3R5B

Easy Installation with Light Component

Compared to conventional models, the new Panasonic splittable ducted weighs in at approximately 10%* lighter. This notion is further emphasised by the unit's ability to split into three components, the heaviest of which totals at 48kg.

* Comparison between S-180PE3R5B and S-180PE2R5B

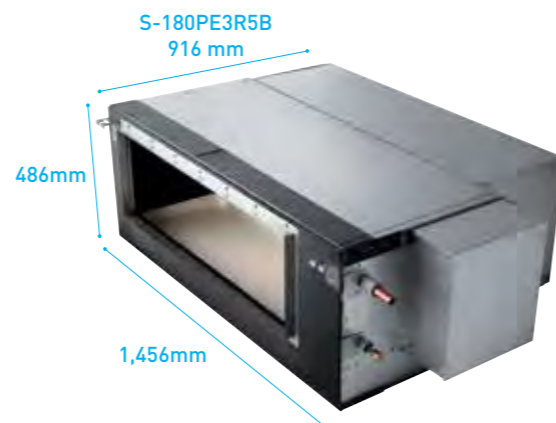

Dimensions of Each Component

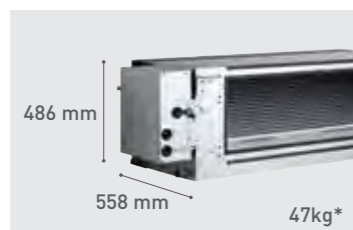

Heat Exchanger

*The weight is for the 18.0kW model. (20.0/22.4kW : 48kg)

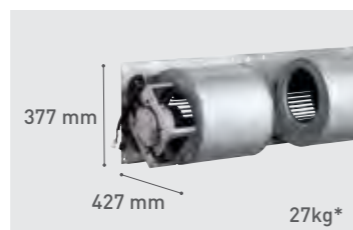

Fan

*The weight is for the 18.0/20.0kW model. (22.4kW : 29kg)

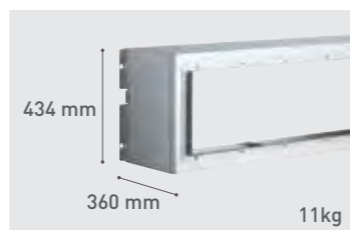

Fan Casing

Specifications of R32 Deluxe Model R32

Capacity		18.0kW	20.0kW	22.4kW
Model Name	Indoor Unit	S-180PE3R5B	S-200PE3R5B	S-224PE3R5B
	Outdoor Unit	U-180PZH2R8	U-200PZH2R8	U-224PZH2R8
Cooling capacity :	kW	18.0 (5.5-20.0)	20.0 (5.7-22.4)	22.4 (5.7-25.0)
	BTU/h	61,400 (18,800-68,200)	68,200 (19,400-76,400)	76,400 (19,400-85,300)
Heating capacity		20.0 (5.5-22.4)	22.4 (5.0-25.0)	25.0 (4.9-28.0)
		68,200 (18,800-76,400)	76,400 (17,100-85,300)	85,300 (16,700-95,500)
EER : COP	W/W	3.20 : 3.75	3.33 : 3.67	3.09 : 3.52
Total power input	Cooling : Heating kW	5.63 : 5.33	6.00 : 6.10	7.24 : 7.10
Indoor Unit				
Power source	Phase/Hz	1 Phase/ 50Hz	1 Phase/ 50Hz	1 Phase/ 50Hz
	V	230V 240V	230V 240V	230V 240V
Current	Cooling : Heating A	3.10 : 3.10 3.00 : 3.00	3.30 : 3.30 3.20 : 3.20	4.20 : 4.20 4.10 : 4.10
Dimensions	H x W x D mm	486 x 1,456 x 916	486 x 1,456 x 916	486 x 1,456 x 916
Heat exchanger	H x W x D mm	486 x 1,456 x 558	486 x 1,456 x 558	486 x 1,456 x 558
Fan	H x W x D mm	377 x 1,150 x 427	377 x 1,150 x 427	377 x 1,150 x 427
Case	H x W x D mm	434 x 1,178 x 360	434 x 1,178 x 360	434 x 1,178 x 360
Net weight	kg	85	86	88
Air volume	Cooling : Heating L/s	1,200 / 1,050 / 883 : 1,200 / 1,050 / 883	1,200 / 1,050 / 883 : 1,200 / 1,050 / 883	1,400 / 1,200 / 983 : 1,400 / 1,200 / 983
External static pressure	Pa	60 (Max.150)	60 (Max.180)	75 (Max.200)
Sound pressure level (H/M/L)	Cooling : Heating dB(A)	46 / 44 / 41 : 46 / 44 / 41	46 / 44 / 41 : 46 / 44 / 41	47 / 45 / 42 : 47 / 45 / 42
Sound power level (H/M/L)	Cooling : Heating dB(A)	78 / 76 / 73 : 78 / 76 / 73	78 / 76 / 73 : 78 / 76 / 73	79 / 77 / 74 : 79 / 77 / 74
Number of fan speeds		3	3	3
Drain pipe size	mm	VP-25	VP-25	VP-25
Outdoor Unit				
Power source	Phase/Hz	3 Phase/ 50Hz	3 Phase/ 50Hz	3 Phase/ 50Hz
	V	400V 415V	400V 415V	400V 415V
Current	Cooling : Heating A	8.00 : 7.55 7.70 : 7.25	8.45 : 8.60 8.15 : 8.30	9.95 : 9.75 9.60 : 9.40
Dimensions	H x W x D mm	1,500 x 980 x 370	1,500 x 980 x 370	1,500 x 980 x 370
Net weight	kg	115	128	128
Air volume	Cooling : Heating L/s	2,733 : 2,733	2,667 : 2,667	2,667 : 2,667
Sound pressure level (Silent mode)	Cooling : Heating dB(A)	58 (56) : 60 (58)	58 (56) : 62 (60)	58 (56) : 62 (60)
Sound power level (Silent mode)	Cooling : Heating dB(A)	76 (74) : 78 (76)	77 (75) : 81 (79)	77 (75) : 81 (79)
Piping connections	Liquid / Gas mm	Ø9.52 / Ø19.05*	Ø12.70 / Ø19.05*	Ø12.70 / Ø19.05*
Pipe length	min. - max. m	5 - 75	5 - 60	5 - 60
Elevation difference (OU located lower, OU located higher)	m	30, 30	30, 30	30, 30
Maximum chargeless length	m	30	30	30
Refrigerant at shipping / Additional gas amount	g	R32 3,400 / 45/60** (g/m)	R32 5,200 / 80 (g/m)	R32 5,200 / 80 (g/m)
Operation ranges	Cooling : Heating °C	-15 to 46 : -20 to 24	-15 to 46 : -20 to 24	-15 to 46 : -20 to 24

Notes:

The Rated Capacity, Power Input and Running Current are measured in accordance with AS/NZS 3823

- Cooling: Indoor temperature: 27°C DB/ 19°C WB, Outdoor temperature: 35°C DB/ 24°C WB
- Heating: Indoor temperature: 20°C DB/ 15°C WB, Outdoor temperature: 7°C DB/ 6°C WB

*Tubing size is Ø25.40 when the piping length is over 50m for U-180PZH2R8 and 30m for U-200PZH2R8 and U-224PZH2R8.

Also, joint needs to be prepared by the site for U-180PZH2R8 when the piping length is over 50m. Please refer to technical documents for more details.

**Additional gas amount is 45g/m when the piping length is under 50m and 60g/m when the piping length is over 50m.

Indoor Unit

High Static Pressure

Slim-line Ducted

Control all aspects of your environment with exceptional performance and quiet operation. A perfect solution when ceiling heights are restricted.

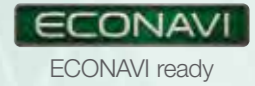

Technical focus

- Space saving 290mm height
- DC fan motor for variable external static pressure control
- Easy to install and maintain
- Accurate temperature control to reduce cold drafts during operation
- Configurable air temperature control

Variable external static pressure control
Optimal airflow set-up is possible for different ducting design and conditions.

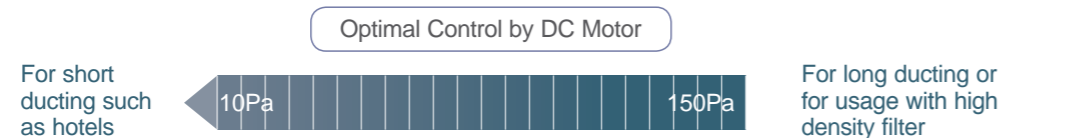

* Please refer to technical documents for detail.

System example

An inspection port (450 mm x 450 mm or larger) is required at the lower side of the indoor unit body.

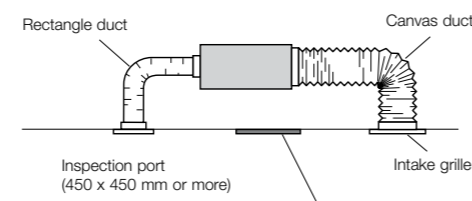

More powerful drain pump

Using a high-lift built-in drain pump, drain piping can be elevated up to 701 mm from the base of the unit.

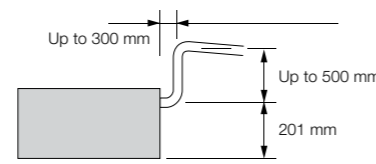

Built-in Drain pump (DC motor pump) External electrical equipment box makes maintenance easy

Space saving height of 290mm for all models

290mm standardised height provides easy and uniform installation for models with different capacities, especially when ceiling heights are restricted.

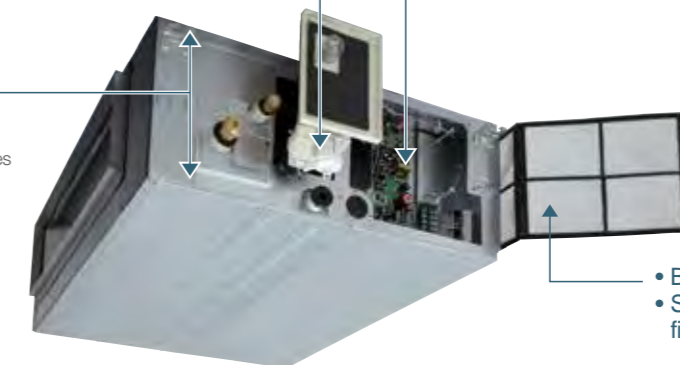

- Built-in filter
- Side removable filter

Discharge air temperature control

- Possible to control discharge air temperature for accurate room temperature control.
- Possible to reduce cold drafts during heating operation.

* Before spec-in, please consult with an authorised Panasonic dealer.

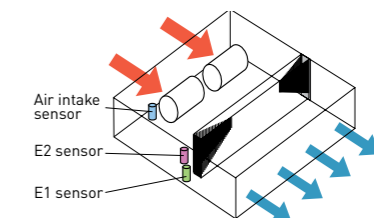

V-shaped heat exchanger

To improve heat exchange efficiency, an original V-shaped heat exchanger was developed incorporating a conventional high-efficiency fan and high-efficiency grooved heat transfer tubes. This increases the heat exchange surface area.

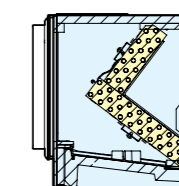

Increases surface area

Indoor Unit: High Static Pressure Slim-line Ducted

Specifications of R32 Deluxe Model R32 REFRIGERANT

Capacity		7.1KW	10.0KW	12.5KW	14.0KW				
Model Name	Indoor Unit	S-71PF1E5B	S-100PF1E5B	S-100PF1E5B	S-125PF1E5B	S-125PF1E5B	S-140PF1E5B	S-140PF1E5B	
	Outdoor Unit	U-71PZH2R5	U-100PZH2R5	U-100PZH2R8	U-125PZH2R5	U-125PZH2R8	U-140PZH2R5	U-140PZH2R8	
Cooling capacity : Heating capacity	kW	7.1 (2.2 - 9.0) 8.0 (2.0 - 9.0)	10.0 (3.1 - 12.5) 11.2 (3.1 - 14.0)	10.0 (3.1 - 12.5) 11.2 (3.1 - 14.0)	12.5 (3.2 - 14.0) 14.0 (3.2 - 16.0)	12.5 (3.2 - 14.0) 14.0 (3.2 - 16.0)	14.0 (3.3 - 16.0) 16.0 (3.3 - 18.0)	14.0 (3.3 - 16.0) 16.0 (3.3 - 18.0)	
	BTU/h	24,200 (7,500 - 30,700) 27,300 (6,800 - 30,700)	34,100 (10,600 - 42,700) 38,200 (10,600 - 47,800)	34,100 (10,600 - 42,700) 38,200 (10,600 - 47,800)	42,700 (10,900 - 47,800) 47,800 (10,900 - 54,600)	42,700 (10,900 - 47,800) 47,800 (10,900 - 54,600)	47,800 (11,300 - 54,600) 54,600 (11,300 - 61,400)	47,800 (11,300 - 54,600) 54,600 (11,300 - 61,400)	
EER : COP	W/W	3.84 : 4.00	4.13 : 4.31	4.13 : 4.31	3.52 : 4.02	3.52 : 4.02	3.26 : 3.65	3.26 : 3.65	
Total power input	Cooling : Heating	1.85 : 2.00	2.42 : 2.60	2.42 : 2.60	3.55 : 3.48	3.55 : 3.48	4.30 : 4.38	4.30 : 4.38	
Indoor Unit									
Power source	Phase/Hz	1 Phase/ 50Hz	1 Phase/ 50Hz	1 Phase/ 50Hz	1 Phase/ 50Hz	1 Phase/ 50Hz	1 Phase/ 50Hz	1 Phase/ 50Hz	
	V	230V 240V	230V 240V	230V 240V	230V 240V	230V 240V	230V 240V	230V 240V	
Current	Cooling : Heating	A	0.89 : 0.89 0.87 : 0.87	1.30 : 1.34 1.27 : 1.29	1.30 : 1.34 1.27 : 1.29	1.44 : 1.42 1.39 : 1.38	1.44 : 1.42 1.39 : 1.38	1.50 : 1.50 1.47 : 1.46	1.50 : 1.50 1.47 : 1.46
Dimensions	H x W x D	mm	290x1,000x700	290x1,400x700	290x1,400x700	290x1,400x700	290x1,400x700	290x1,400x700	
Net weight		kg	33	45	45	45	45	45	
Air volume	Cooling : Heating	L/s	350 : 350	533 : 533	533 : 533	566 : 566	566 : 566	600 : 600	
External static pressure		Pa	70 (10 - 150)	100 (10 - 150)	100 (10 - 150)	100 (10 - 150)	100 (10 - 150)	100 (10 - 150)	
Sound pressure level (H/M/L)	Cooling : Heating	dB(A)	35 / 32 / 26 : 35 / 32 / 26	38 / 34 / 31 : 38 / 34 / 31	38 / 34 / 31 : 38 / 34 / 31	39 / 35 / 32 : 39 / 35 / 32	39 / 35 / 32 : 39 / 35 / 32	40 / 36 / 33 : 40 / 36 / 33	40 / 36 / 33 : 40 / 36 / 33
Sound power level (H/M/L)	Cooling : Heating	dB(A)	57 / 54 / 48 : 57 / 54 / 48	60 / 56 / 53 : 60 / 56 / 53	60 / 56 / 53 : 60 / 56 / 53	61 / 57 / 54 : 61 / 57 / 54	61 / 57 / 54 : 61 / 57 / 54	62 / 58 / 55 : 62 / 58 / 55	62 / 58 / 55 : 62 / 58 / 55
Number of fan speeds			3	3	3	3	3	3	
Drain piping		mm	VP-25	VP-25	VP-25	VP-25	VP-25	VP-25	
Outdoor Unit									
Power source	Phase/Hz	1 Phase/ 50Hz	1 Phase/ 50Hz	3 Phase/ 50Hz	1 Phase/ 50Hz	3 Phase/ 50Hz	1 Phase/ 50Hz	3 Phase/ 50Hz	
	V	230V 240V	230V 240V	400V 415V	230V 240V	400V 415V	230V 240V	400V 415V	
Current	Cooling : Heating	A	8.00 : 8.50 7.65 : 8.25	10.2 : 11.0 9.75 : 10.5	3.40 : 3.70 3.30 : 3.55	15.2 : 14.9 14.6 : 14.3	5.10 : 5.00 4.95 : 4.85	18.6 : 19.0 17.8 : 18.2	6.25 : 6.40 6.05 : 6.15
Dimensions	H x W x D	mm	996 x 940 x 340	1,416 x 940 x 340	1,416 x 940 x 340	1,416 x 940 x 340	1,416 x 940 x 340	1,416 x 940 x 340	
Net weight		kg	68	99	99	99	99	99	
Air volume	Cooling : Heating	L/s	1,017 : 1,000	1,967 : 1,800	1,967 : 1,800	2,083 : 1,867	2,083 : 1,867	2,150 : 1,933	2,150 : 1,933
Sound pressure level	Cooling : Heating	dB(A)	48 (46) : 50 (48)	52 (50) : 52 (50)	52 (50) : 52 (50)	53 (51) : 53 (51)	53 (51) : 53 (51)	54 (52) : 54 (52)	54 (52) : 54 (52)
Sound power level	Cooling : Heating	dB(A)	64 (62) : 66 (64)	68 (66) : 68 (66)	68 (66) : 68 (66)	69 (67) : 69 (67)	69 (67) : 69 (67)	70 (68) : 70 (68)	70 (68) : 70 (68)
Piping connections	Liquid / Gas	mm	Ø9.52 / Ø15.88	Ø9.52 / Ø15.88	Ø9.52 / Ø15.88	Ø9.52 / Ø15.88	Ø9.52 / Ø15.88	Ø9.52 / Ø15.88	
Pipe length	min. - max.	m	5 - 50	5 - 85	5 - 85	5 - 85	5 - 85	5 - 85	
Elevation difference (OU located lower, OU located higher)		m	15, 30	15, 30	15, 30	15, 30	15, 30	15, 30	
Maximum chargeless length		m	30	30	30	30	30	30	
Refrigerant at shipping / Additional gas amount		g	R32 1,950 / 45 (g/m)	R32 3,050 / 45 (g/m)	R32 3,050 / 45 (g/m)	R32 3,050 / 45 (g/m)	R32 3,050 / 45 (g/m)	R32 3,050 / 45 (g/m)	
Operation ranges	Cooling : Heating	°C	-15 to 46 : -20 to 24	-15 to 46 : -20 to 24	-15 to 46 : -20 to 24	-15 to 46 : -20 to 24	-15 to 46 : -20 to 24	-15 to 46 : -20 to 24	

Specifications of R32 Compact Model R32 REFRIGERANT

Capacity		6.0KW	7.1KW	10.0KW	12.5KW	14.0KW				
Model Name	Indoor Unit	S-60PF1E5B	S-71PF1E5B	S-100PF1E5B	S-100PF1E5B	S-125PF1E5B	S-125PF1E5B	S-140PF1E5B	S-140PF1E5B	
	Outdoor Unit	U-60PZ2R5	U-71PZ2R5	U-100PZ2R5	U-100PZ2R8	U-125PZ2R5	U-125PZ2R8	U-140PZ2R5	U-140PZ2R8	
Cooling capacity : Heating capacity	kW	6.0 (2.0 - 7.1) 6.0 (1.8 - 7.6)	7.1 (2.0 - 8.0) 7.1 (1.8 - 8.6)	10.0 (3.0 - 11.5) 10.0 (3.0 - 14.0)	10.0 (3.0 - 11.5) 10.0 (3.0 - 14.0)	12.5 (3.2 - 13.5) 12.5 (3.3 - 15.0)	12.5 (3.2 - 13.5) 12.5 (3.3 - 15.0)	14.0 (3.3 - 15.0) 14.0 (3.4 - 16.0)	14.0 (3.3 - 15.0) 14.0 (3.4 - 16.0)	
	BTU/h	20,500 (6,800 - 24,200) 20,500 (6,100 - 25,900)	24,200 (6,800 - 27,300) 24,200 (6,100 - 29,300)	34,100 (10,200 - 39,200) 34,100 (10,200 - 47,800)	34,100 (10,200 - 39,200) 34,100 (10,200 - 47,800)	42,700 (10,900 - 46,100) 42,700 (11,300 - 51,200)	42,700 (10,900 - 46,100) 42,700 (11,300 - 51,200)	47,800 (11,300 - 51,200) 47,800 (11,600 - 54,600)	47,800 (11,300 - 51,200) 47,800 (11,600 - 54,600)	
EER : COP	W/W	3.80 : 4.51 3.80 : 4.51	3.41 : 4.15 3.41 : 4.15	3.66 : 4.31	3.66 : 4.31	3.52 : 4.02	3.52 : 4.02	3.18 : 3.79	3.18 : 3.79	
Total power input	Cooling : Heating	1.58 : 1.33	2.08 : 1.71	2.73 : 2.32	2.73 : 2.32	3.55 : 3.11	3.55 : 3.11	4.40 : 3.69	4.40 : 3.69	
Indoor Unit										
Power source	Phase/Hz	1 Phase/ 50Hz	1 Phase/ 50Hz	1 Phase/ 50Hz	1 Phase/ 50Hz	1 Phase/ 50Hz	1 Phase/ 50Hz	1 Phase/ 50Hz	1 Phase/ 50Hz	
	V	230V 240V	230V 240V	230V 240V	230V 240V	230V 240V	230V 240V	230V 240V	230V 240V	
Current	Cooling : Heating	A	0.89 : 0.89 0.87 : 0.87	0.89 : 0.89 0.87 : 0.87	1.30 : 1.34 1.27 : 1.29	1.30 : 1.34 1.27 : 1.29	1.44 : 1.42 1.39 : 1.38	1.44 : 1.42 1.39 : 1.38	1.50 : 1.50 1.47 : 1.46	1.50 : 1.50 1.47 : 1.46
Dimensions	H x W x D	mm	290x1,000 x700	290x1,000 x700	290x1,400 x700	290x1,400 x700	290x1,400 x700	290x1,400 x700	290x1,400 x700	
Net weight		kg	33	33	45	45	45	45	45	
Air volume	Cooling : Heating	L/s	350 : 350	350 : 350	533 : 533	533 : 533	566 : 566	566 : 566	600 : 600	
External static pressure		Pa	70 (10 - 150)	70 (10 - 150)	100 (10 - 150)	100 (10 - 150)	100 (10 - 150)	100 (10 - 150)	100 (10 - 150)	
Sound pressure level (H/M/L)	Cooling : Heating	dB(A)	35 / 32 / 26 : 35 / 32 / 26	35 / 32 / 26 : 35 / 32 / 26	38 / 34 / 31 : 38 / 34 / 31	38 / 34 / 31 : 38 / 34 / 31	39 / 35 / 32 : 39 / 35 / 32	39 / 35 / 32 : 39 / 35 / 32	40 / 36 / 33 : 40 / 36 / 33	40 / 36 / 33 : 40 / 36 / 33
Sound power level (H/M/L)	Cooling : Heating	dB(A)	57 / 54 / 48 : 57 / 54 / 48	57 / 54 / 48 : 57 / 54 / 48	60 / 56 / 53 : 60 / 56 / 53	60 / 56 / 53 : 60 / 56 / 53	61 / 57 / 54 : 61 / 57 / 54	61 / 57 / 54 : 61 / 57 / 54	62 / 58 / 55 : 62 / 58 / 55	62 / 58 / 55 : 62 / 58 / 55
Number of fan speeds			3	3	3	3	3	3	3	
Drain piping		mm	VP-25	VP-25	VP-25	VP-25	VP-25	VP-25	VP-25	
Outdoor Unit										
Power source	Phase/Hz	1 Phase/ 50Hz	1 Phase/ 50Hz	1 Phase/ 50Hz	3 Phase/ 50Hz	1 Phase/ 50Hz	3 Phase/ 50Hz	1 Phase/ 50Hz	3 Phase/ 50Hz	
	V	230V 240V	230V 240V	230V 240V	400V 415V	230V 240V	400V 415V	230V 240V	400V 415V	
Current	Cooling : Heating	A	7.05 : 5.85 6.75 : 5.60	9.35 : 7.70 8.95 : 7.35	11.6 : 9.70 11.1 : 9.30	3.95 : 3.30 3.80 : 3.20	15.5 : 13.4 14.8 : 12.9	5.10 : 4.45 4.95 : 4.30	19.3 : 16.0 18.6 : 15.3	6.40 : 5.30 6.15 : 5.15
Dimensions	H x W x D	mm	695 x 875 x 320	695 x 875 x 320	996 x 980 x 370	996 x 980 x 370	996 x 980 x 370	996 x 980 x 370	996 x 980 x 370	
Net weight		kg	44	44	90	90	90	90	90	
Air volume	Cooling : Heating	L/s	750 : 750	867 : 750	1,285 : 1,169	1,285 : 1,169	1,436 : 1,302	1,436 : 1,302	1,486 : 1,386	1,486 : 1,386
Sound pressure level	Cooling : Heating	dB(A)	46 (44) : 48 (46)	49 (47) : 49 (47)	52 (50) : 52 (50)	52 (50) : 52 (50)	55 (53) : 55 (53)	55 (53) : 55 (53)	56 (54) : 56 (54)	56 (54) : 56 (54)
Sound power level	Cooling : Heating	dB(A)	65 (63) : 66 (64)	67 (65) : 67 (65)	68 (66) : 67 (65)	68 (66) : 67 (65)	70 (68) : 70 (68)	71 (69) : 71 (69)	71 (69) : 71 (69)	
Piping connections	Liquid / Gas	mm	Ø9.52 / Ø15.88	Ø9.52 / Ø15.88	Ø9.52 / Ø15.88	Ø9.52 / Ø15.88	Ø9.52 / Ø15.88	Ø9.52 / Ø15.88	Ø9.52 / Ø15.88	
Pipe length	min. - max.	m	3 - 40	3 - 40	5 - 50	5 - 50	5 - 50	5 - 50	5 - 50	
Elevation difference (OU located lower, OU located higher)		m	15, 30	15, 30	15, 30	15, 30	15, 30	15, 30	15, 30	
Maximum chargeless length		m	30	30	30	30	30	30	30	
Refrigerant at shipping / Additional gas amount		g	R32 1,450 / 35 (g/m)	R32 1,450 / 35 (g/m)	R32 2,600 / 45 (g/m)	R32 2,600 / 45 (g/m)	R32 2,980 / 45 (g/m)	R32 2,980 / 45 (g/m)	R32 2,980 / 45 (g/m)	
Operation ranges	Cooling : Heating	°C	-10 to 43 : -15 to 24	-10 to 43 : -15 to 24	-10 to 43 : -15 to 24	-10 to 43 : -15 to 24	-10 to 43 : -15 to 24	-10 to 43 : -15 to 24	-10 to 43 : -15 to 24	

Notes:
The Rated Capacity, Power Input and Running Current are measured in accordance with AS/NZS 3823
• Cooling: Indoor temperature: 27°C DB/ 19°C WB, Outdoor temperature: 35°C DB/ 24°C WB
• Heating: Indoor temperature: 20°C DB/ 15°C WB, Outdoor temperature: 7°C DB/ 6°C WB

Indoor Unit 4-WAY Cassette

Featuring uniform cooling, easy installation, and with a sleek exterior, this unit is the perfect match for your modern home.

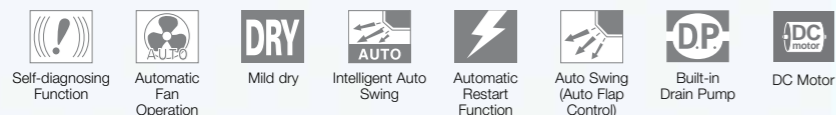

Technical focus

- Compact design
- Low sound levels
- DC fan motor for increased efficiency
- Powerful drain pump gives 850 mm lift
- Lightweight design
- Fresh air knockout
- Branch duct connection
- Optional air-intake plenum CZ-FDU3

360° Wide & Comfortable Airflow

Our design features wide-angle outlets and flaps that were designed through expert mechanics and prototype tests. Air from the center is sent farther and the air blown out of the larger, side flaps spreads throughout the room. The air comes from all four sides of the unit and expands gently in a circle centered on the indoor unit.

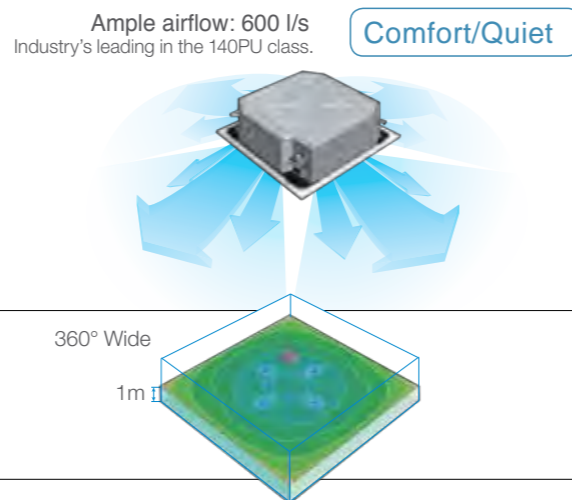

Wide Flap

Adding a sub flap and widening the main flap have reduced turbulence and increased airflow. Also, setting the jetting port at a wider angle allows the airflow to reach the corners of the room more quickly.

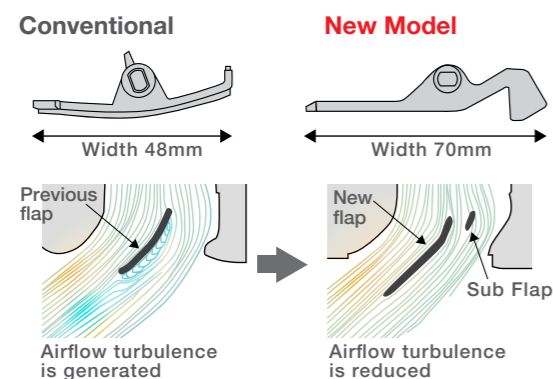

3D Turbo Fan

Using a twisted 3D blade made the unit slimmer and more compact, while also increasing the airflow. A 5-Speed mode allows the airflow to be adjusted in 5 steps to suit the situation.

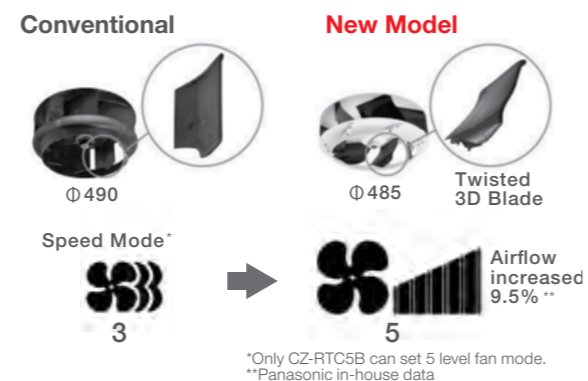

High-Ceiling Installation (Up to 5 m for 10.0kW+ models)

The units can be installed in rooms with high ceilings, where they provide ample floor-level heating in the winter. (See ceiling height guidelines below.)

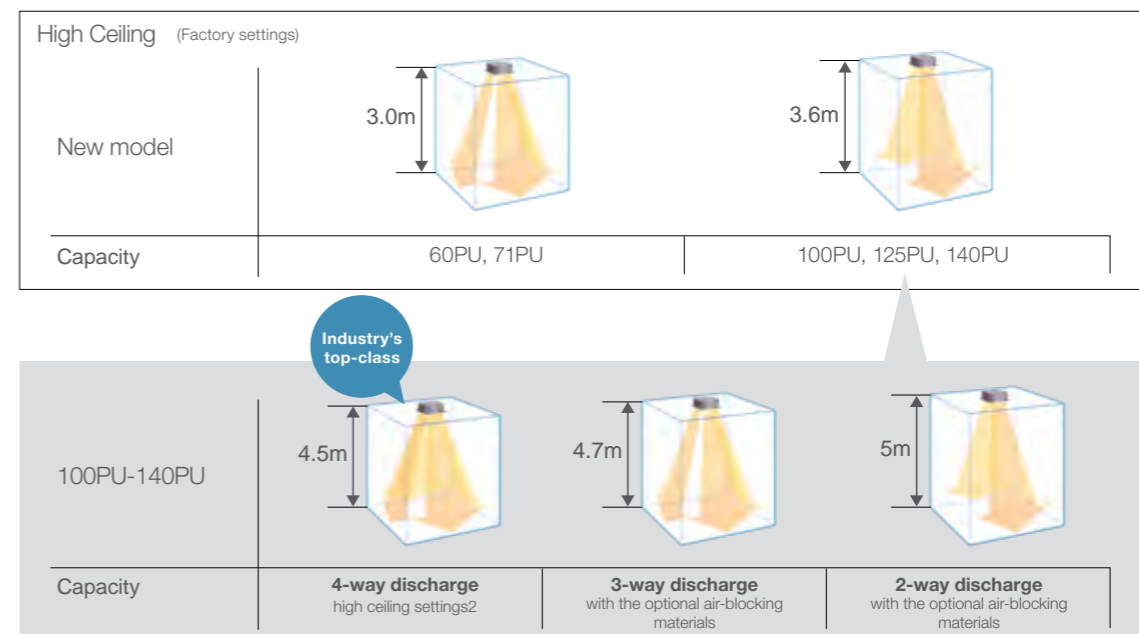

Ceiling height guidelines

Indoor unit	*1 settings				
	4-way discharge Factory settings 1	High ceiling setting 1	High ceiling setting 2	3-way discharge (optional air-blocking materials)	2-way discharge (optional air-blocking materials) *2
60PU-71PU	3.0	3.3	3.6	3.8	4.2
100PU, 125PU, 140PU	3.6	3.9	4.5	4.7	5.0

*1 When using the unit in a configuration other than the factory settings, it is necessary to make settings on site to increase airflow.
*2 Use air-blocking materials (CZ-CFU3) to completely block two discharge outlets for 2-way airflow.

Air Purification by nanoe™ Technology



Approved by the National Asthma Council Australia and Asthma+Respiratory Foundation NZ



nanoe™ is Panasonic's unique air purifying technology. Introduced in 2003, nanoe™ has brought comfortable, clean air to a wide variety of living environments. By conducting further research & development, Panasonic has now succeeded in developing nanoe™ X, with dramatically increased performance.

nanoe™ X Improves Air Quality

Panasonic's unique nanoe™ X has an outstanding effect on various air pollutants, including allergens, viruses and bacteria, as well as cigarette and other household odours. It takes reliable air purification performance another step forward.



Deodorises unpleasant odours^{*1 *2 *3}



nanoe™ X works on the substances responsible for odours to deodorise them.

Inhibits bacteria and virus^{*4 *5 *6 *7 *8}



nanoe™ X suppresses airborne particles including bacteria, viruses and mould.

^{*1} Adhering odour of cigarette [Effectiveness]: Decrease by 1.7 level [Testing Institute]: Gunma Research Center [Test Report No]: No. 27055 [Result]: Decrease in odour intensity by 0.7 level after 2 hour of operation. ^{*2} Floating odour of cigarette [Effectiveness]: Decrease by 0.8 level [Test Lab Size]: 136.5m³ [Testing Institute]: Panasonic Corporation Product Analysis Center [Test Report No]: 4AA33-170117-A01 [Result]: Decrease in odour intensity by 0.8 level after 2 hour of operation. ^{*3} Adhering odour of Meat Grilling [Effectiveness]: Decrease by 0.9 level [Test Lab Size]: 67.7m³ [Testing Institute]: Panasonic Corporation Product Analysis Center [Test Report No]: 4AA33-170203-A03 [Result]: Decrease in odour intensity by 0.9 level after 2 hour of operation. ^{*4} Mould [Effectiveness]: Inhibit Mould Growth [Testing Institute]: Japan Food Research Laboratories [Test Report No]: 13044083002-01 [Result]: The growth of the subject was inhibited after 8-hour nanoe™ operation. ^{*5} Bacteria [Effectiveness]: 99% [Testing Institute]: Kitasato Research Center for Environmental Science [Test Report No]: KRCES-Env. Test Report 24_0301_1 [Result]: 99% of deactivation after 4-hour nanoe™ operation. ^{*6} Bacteria [Effectiveness]: 99% [Testing Institute]: Japan Food Research Laboratories [Test Report No]: 13044083002-01 [Result]: The growth of the subject was inhibited after 8-hour nanoe™ operation. ^{*7} Viruses [Effectiveness]: 99% [Testing Institute]: Kitasato Research Center for Environmental Science [Test Report No]: KRCES-Env. Test Report 24_0300_1 [Result]: 99% of deactivation after 6-hour nanoe™ operation. ^{*8} Viruses [Effectiveness]: 99% [Testing Institute]: Japan Food Research Laboratories [Test Report No]: 13001265005-01 [Result]: 99% of deactivation after 8-hour nanoe™ operation.

nanoe™ X Mechanism

Amount of OH radicals increases without increasing amount of ozone, leading to improved effectiveness!

Generation Mechanism

nanoe™ X is generated from moisture in the air

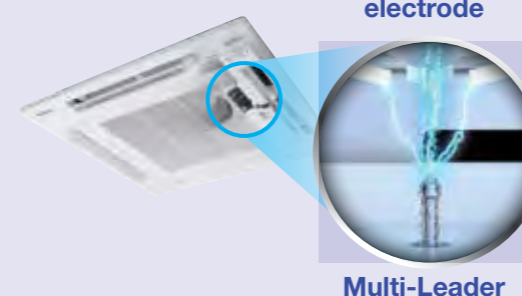

Structure

OH radical

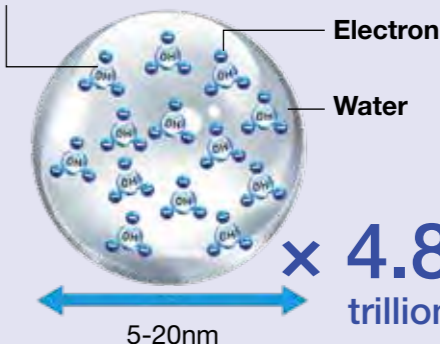

How to Deodorise Odour^{*1 *2 *3}

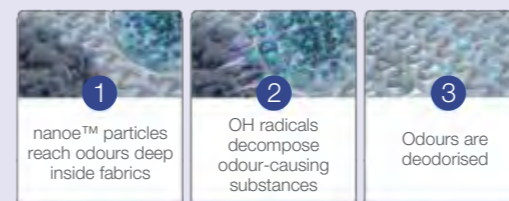

How to Inhibit Bacteria, Virus and Mould^{*4 *5 *6 *7 *8}

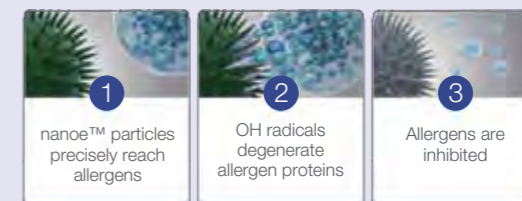

Also Cleans the Air When Not Air Conditioning

You can also use nanoe™ X in Fan mode when you're not cooling or heating the room. For example, you can use nanoe™ X to effectively suppress bacteria and odours without using excessive electricity when the office is empty or after business hours in a restaurant.

Business Time



AC Mode + nanoe™ X
nanoe™ X purifies the room while maintaining the comfort temperature when people are in presence.

Closed Time



FAN Mode + nanoe™ X
After closing shops and facilities, nanoe™ X can perform air purification while they are not in use.

Case Examples of nanoe™

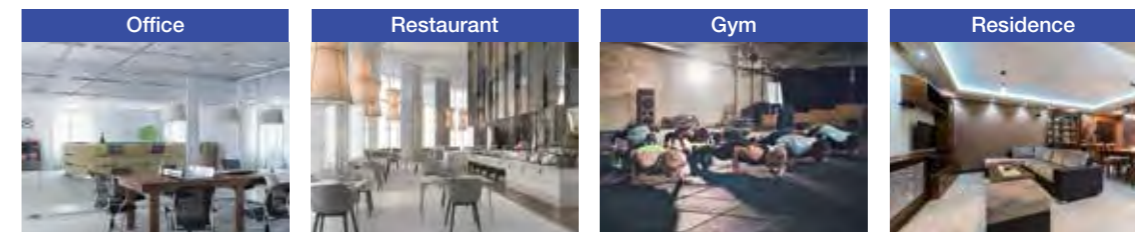

Indoor Unit: 4-WAY Cassette

Specifications of R32 Deluxe Model R32

Capacity		7.1kW	10.0kW	12.5kW	14.0kW				
Model Name	Indoor Unit	S-71PU2E5B	S-100PU2E5B	S-100PU2E5B	S-125PU2E5B	S-125PU2E5B	S-140PU2E5B	S-140PU2E5B	
	Outdoor Unit	U-71PZH2R5	U-100PZH2R5	U-100PZH2R8	U-125PZH2R5	U-125PZH2R8	U-140PZH2R5	U-140PZH2R8	
Panel		Standard type:CZ-KPU3H; ECONAVI type:CZ-KPU3A		Standard type:CZ-KPU3H; ECONAVI type:CZ-KPU3A		Standard type:CZ-KPU3H; ECONAVI type:CZ-KPU3A		Standard type:CZ-KPU3H; ECONAVI type:CZ-KPU3A	
Cooling capacity	kW	7.1 (2.2 - 9.0)	10.0 (3.1 - 12.5)	10.0 (3.1 - 12.5)	12.5 (3.2 - 14.0)	12.5 (3.2 - 14.0)	14.0 (3.3 - 16.0)	14.0 (3.3 - 16.0)	
		8.0 (2.0 - 9.0)	11.2 (3.1 - 14.0)	11.2 (3.1 - 14.0)	14.0 (3.2 - 16.0)	14.0 (3.2 - 16.0)	16.0 (3.3 - 18.0)	16.0 (3.3 - 18.0)	
Heating capacity	BTU/h	24,200 (7,500 - 30,700)	34,100 (10,600 - 42,700)	34,100 (10,600 - 42,700)	42,700 (10,900 - 47,800)	42,700 (10,900 - 47,800)	47,800 (11,300 - 54,600)	47,800 (11,300 - 54,600)	
		27,300 (6,800 - 30,700)	38,200 (10,600 - 47,800)	38,200 (10,600 - 47,800)	47,800 (10,900 - 54,600)	47,800 (10,900 - 54,600)	54,600 (11,300 - 61,400)	54,600 (11,300 - 61,400)	
EER : COP	Cooling : Heating	4.06 : 4.30	4.41 : 5.00	4.41 : 5.00	3.80 : 4.61	3.80 : 4.61	3.41 : 4.30	3.41 : 4.30	
Total power input	Cooling : Heating	1.75 : 1.86	2.27 : 2.24	2.27 : 2.24	3.29 : 3.04	3.29 : 3.04	4.11 : 3.72	4.11 : 3.72	
Indoor Unit									
Power source	Phase/Hz	1 Phase/ 50Hz		1 Phase/ 50Hz		1 Phase/ 50Hz		1 Phase/ 50Hz	
		230V 240V		230V 240V		230V 240V		230V 240V	
Current	Cooling : Heating	A		A		A		A	
		0.39 : 0.38 0.38 : 0.37		0.79 : 0.78 0.76 : 0.75		0.79 : 0.78 0.76 : 0.75		0.88 : 0.87 0.85 : 0.84	
Dimensions	H x W x D	mm		mm		mm		mm	
		256x840x840		319x840x840		319x840x840		319x840x840	
Net weight	Panel	mm		mm		mm		mm	
		33.5x950x950		33.5x950x950		33.5x950x950		33.5x950x950	
Air volume	Cooling : Heating	L/s		L/s		L/s		L/s	
		366 / 266 / 216 : 366 / 266 / 216		600 / 433 / 300 : 600 / 433 / 300		600 / 433 / 300 : 600 / 433 / 300		616 / 450 / 316 : 616 / 450 / 316	
Sound pressure level (H/M/L)	Cooling : Heating	dB(A)		dB(A)		dB(A)		dB(A)	
		37 / 31 / 28 : 37 / 31 / 28		45 / 38 / 32 : 45 / 38 / 32		45 / 38 / 32 : 45 / 38 / 32		46 / 39 / 33 : 46 / 39 / 33	
Sound power level (H/M/L)	Cooling : Heating	dB(A)		dB(A)		dB(A)		dB(A)	
		52 / 46 / 43 : 52 / 46 / 43		60 / 53 / 47 : 60 / 53 / 47		60 / 53 / 47 : 60 / 53 / 47		61 / 54 / 48 : 61 / 54 / 48	
Number of fan speeds	Drain pipe size	mm		mm		mm		mm	
		VP-25		VP-25		VP-25		VP-25	
Outdoor Unit									
Power source	Phase/Hz	1 Phase/ 50Hz		1 Phase/ 50Hz		3 Phase/ 50Hz		1 Phase/ 50Hz	
		230V 240V		230V 240V		400V 415V		230V 240V	
Current	Cooling : Heating	A		A		A		A	
		7.90 : 8.25 7.55 : 8.00		9.95 : 9.80 9.50 : 9.40		3.35 : 3.30 3.20 : 3.15		14.5 : 13.4 13.9 : 12.8	
Dimensions	H x W x D	mm		mm		mm		mm	
		996 x 940 x 340		1,416 x 940 x 340		1,416 x 940 x 340		1,416 x 940 x 340	
Net weight	Panel	kg		kg		kg		kg	
		68		99		99		99	
Air volume	Cooling : Heating	L/s		L/s		L/s		L/s	
		1,017 : 1,000		1,967 : 1,800		1,967 : 1,800		2,083 : 1,867	
Sound pressure level (Silent mode)	Cooling : Heating	dB(A)		dB(A)		dB(A)		dB(A)	
		48 (46) : 50 (48)		52 (50) : 52 (50)		52 (50) : 52 (50)		53 (51) : 53 (51)	
Sound power level (Silent mode)	Cooling : Heating	dB(A)		dB(A)		dB(A)		dB(A)	
		64 (62) : 66 (64)		68 (66) : 68 (66)		68 (66) : 68 (66)		69 (67) : 69 (67)	
Piping connections	Liquid / Gas	mm		mm		mm		mm	
		Ø9.52 / Ø15.88		Ø9.52 / Ø15.88		Ø9.52 / Ø15.88		Ø9.52 / Ø15.88	
Pipe length	min. - max.	m		m		m		m	
		5 - 50		5 - 85		5 - 85		5 - 85	
Elevation difference (OU located lower, OU located higher)	Maximum chargeless length	m		m		m		m	
		15, 30		15, 30		15, 30		15, 30	
Refrigerant at shipping / Additional gas amount	Operation ranges	g		g		g		g	
		R32 1,950 / 45 (g/m)		R32 3,050 / 45 (g/m)		R32 3,050 / 45 (g/m)		R32 3,050 / 45 (g/m)	
Cooling : Heating		°C		°C		°C		°C	
		-15 to 46 : -20 to 24		-15 to 46 : -20 to 24		-15 to 46 : -20 to 24		-15 to 46 : -20 to 24	

Specifications of R32 Compact Model R32

Capacity		6.0kW	7.1kW	10.0kW	12.5kW	14.0kW			
Model Name	Indoor Unit	S-60PU2E5B	S-71PU2E5B	S-100PU2E5B	S-100PU2E5B	S-125PU2E5B	S-125PU2E5B	S-140PU2E5B	S-140PU2E5B
	Outdoor Unit	U-60PZ2R5	U-71PZ2R5	U-100PZ2R5	U-100PZ2R8	U-125PZ2R5	U-125PZ2R8	U-140PZ2R5	U-140PZ2R8
Panel		Standard type:CZ-KPU3H; ECONAVI type:CZ-KPU3A		Standard type:CZ-KPU3H; ECONAVI type:CZ-KPU3A		Standard type:CZ-KPU3H; ECONAVI type:CZ-KPU3A		Standard type:CZ-KPU3H; ECONAVI type:CZ-KPU3A	
Cooling capacity	kW	6.0 (2.0 - 7.1)	7.1 (2.0 - 8.0)	10.0 (3.0 - 11.5)	10.0 (3.0-11.5)	12.5 (3.2 - 13.5)	12.5 (3.2 - 13.5)	14.0 (3.3 - 15.0)	14.0 (3.3 - 15.0)
		6.0 (1.8 - 7.6)	7.1 (1.8 - 8.6)	10.0 (3.0 - 14.0)	10.0 (3.0 - 14.0)	12.5 (3.3 - 15.0)	12.5 (3.3 - 15.0)	14.0 (3.4 - 16.0)	14.0 (3.4 - 16.0)
Heating capacity	BTU/h	20,500 (6,800 - 24,200)	24,200 (6,800 - 27,300)	34,100 (10,200 - 39,200)	34,100 (10,200 - 39,200)	42,700 (10,900 - 46,100)	42,700 (10,900 - 46,100)	47,800 (11,300 - 51,200)	47,800 (11,300 - 51,200)
		20,500 (6,100 - 25,900)	24,200 (6,100 - 29,300)	34,100 (10,200 - 47,800)	34,100 (10,200 - 47,800)	42,700 (11,300 - 51,200)	42,700 (11,300 - 51,200)	47,800 (11,600 - 54,600)	47,800 (11,600 - 54,600)
EER : COP	Cooling : Heating	4.05 : 4.80 4.05 : 4.80	3.68 : 4.38 3.68 : 4.38	3.82 : 4.93 3.82 : 4.93	3.82 : 4.93 3.82 : 4.93	3.58 : 4.43 3.58 : 4.43	3.58 : 4.43 3.58 : 4.43	3.23 : 4.18 3.23 : 4.18	3.23 : 4.18 3.23 : 4.18
Total power input	Cooling : Heating	1.48 : 1.25	1.93 : 1.62	2.62 : 2.03	2.62 : 2.03	3.49 : 2.82	3.49 : 2.82	4.34 : 3.35	4.34 : 3.35
Indoor Unit									
Power source	Phase/Hz	1 Phase/ 50Hz		1 Phase/ 50Hz		1 Phase/ 50Hz		1 Phase/ 50Hz	
		230V 240V		230V 240V		230V 240V		230V 240V	
Current	Cooling : Heating	A		A		A		A	
		0.35 : 0.34 0.34 : 0.33		0.39 : 0.38 0.38 : 0.37		0.79 : 0.78 0.76 : 0.75		0.88 : 0.87 0.85 : 0.84	
Dimensions	H x W x D	mm		mm		mm		mm	
		256x840 x840		319x840 x840		319x840 x840		319x840 x840	
Net weight	Panel	mm		mm		mm		mm	
		33.5 x 950 x 950		33.5 x 950 x 950		33.5 x 950 x 950		33.5 x 950 x 950	
Air volume	Cooling : Heating	L/s		L/s		L/s		L/s	
		350 / 266 / 216 : 350 / 266 / 216		366 / 266 / 216 : 366 / 266 / 216		600 / 433 / 300 : 600 / 433 / 300		616 / 450 / 316 : 616 / 450 / 316	
Sound pressure level (H/M/L)	Cooling : Heating	dB(A)		dB(A)		dB(A)		dB(A)	
		36 / 31 / 28 : 36 / 31 / 28		37 / 31 / 28 : 37 / 31 / 28		45 / 38 / 32 : 45 / 38 / 32		46 / 39 / 33 : 45 / 39 / 33	
Sound power level (H/M/L)	Cooling : Heating	dB(A)		dB(A)		dB(A)		dB(A)	
		51 / 46 / 43 : 51 / 46 / 43		52 / 46 / 43 : 52 / 46 / 43		60 / 53 / 47 : 60 / 53 / 47		61 / 54 / 48 : 61 / 54 / 48	
Number of fan speeds	Drain pipe size	mm		mm		mm		mm	
		VP-25		VP-25		VP-25		VP-25	
Outdoor Unit									
Power source	Phase/Hz	1 Phase/ 50Hz		1 Phase/ 50Hz		3 Phase/ 50Hz		1 Phase/ 50Hz	
		230V 240V		230V 240V		400V 415V		230V 240V	
Current	Cooling : Heating	A		A		A		A	
		6.95 : 5.85 6.70 : 5.60		9.00 : 7.65 8.65 : 7.30		11.5 : 8.85 11.1 : 8.50		15.6 : 12.6 15.0 : 12.0	
Dimensions	H x W x D	mm		mm		mm		mm	
		695 x 875 x 320		695 x 875 x 320		996 x 980 x 370		996 x 980 x 370	
Net weight	Panel	kg		kg		kg		kg	
		44		44		90		94	
Air volume	Cooling : Heating	L/s		L/s		L/s		L/s	
		750 : 750		867 : 750		1,285 : 1,169		1,436 : 1,302	
Sound pressure level (Silent mode)	Cooling : Heating	dB(A)		dB(A)		dB(A)		dB(A)	
		46 (44) : 48 (46)		49 (47) : 49 (47)		52 (50) : 52 (50)		55 (53) : 55 (53)	
Sound power level (Silent mode)	Cooling : Heating	dB(A)		dB(A)		dB(A)		dB(A)	
		65 (63) : 66 (64)		67 (65) : 67 (65)		68 (66) : 67 (65)		70 (68) : 70 (68)	
Piping connections	Liquid / Gas	mm		mm		mm		mm	
		Ø9.52 / Ø15.88		Ø9.52 / Ø15.88		Ø9.52 / Ø15.88		Ø9.52 / Ø15.88	
Pipe length	min. - max.	m		m		m		m	
		3 - 40		3 - 40		5 - 50		5 - 50	
Elevation difference (OU located lower, OU located higher)	Maximum chargeless length	m		m		m		m	
		15, 30		15, 30		15, 30		15, 30	
Refrigerant at shipping / Additional gas amount	Operation ranges	g		g		g		g	
		R32 1,450 / 35 (g/m)		R32 1,450 / 35 (g/m)		R32 2,600 / 45 (g/m)		R32 2,600 / 45 (g/m)	
Cooling : Heating		°C		°C		°C		°C	
		-10 to 43 : -15 to 24		-10 to 43 : -15 to 24		-10 to 43 : -15 to 24		-10 to 43 : -15 to 24	

Notes:
 The Rated Capacity, Power Input and Running Current are measured in accordance with AS/NZS 3823
 • Cooling: Indoor temperature: 27°C DB/ 19°C WB, Outdoor temperature: 35°C DB/ 24°C WB
 • Heating: Indoor temperature: 20°C DB/ 15°C WB, Outdoor temperature: 7°C DB/ 6°C WB
 * When using CZ-RTC5B, the number of fan speed will be 3 for other controller.

Indoor Unit Under Ceiling

Providing outstanding energy-saving performance, comfort and long-distance airflow distribution, these units are perfect for retail stores and schools.

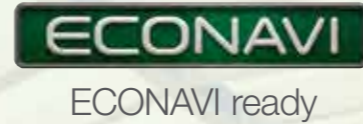

S-60PT2E5B
S-71PT2E5B



S-100PT2E5B
S-125PT2E5B
S-140PT2E5B

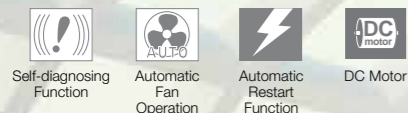
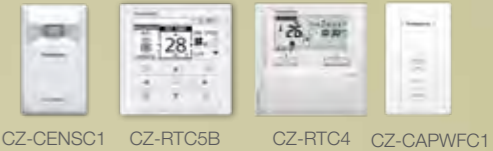

Compact Looking, Stylish, One-Motion Design

With its streamlined, one-motion form, the unit looks thin and compact when installed for a neat appearance in any room. When not operating, the louver closes to provide an elegant look while also keeping the unit clean.



Energy-Saving Technology Delivering Top-Class Efficiency

Optimisation of the shape of the casing and fan assures bigger air flow and higher efficiency. Energy-saving performance is top class in the industry.

Top Class Energy Saving

New DC fan motor



Large Diagonal Air Flow Fan

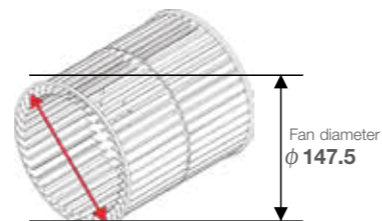

Comfortable, Long-Distance Airflow Distribution

The shape of the outlet has been optimised to provide long-distance air flow distribution. Even in long rooms, air flow reaches every corner for exceptionally comfortable air conditioning.

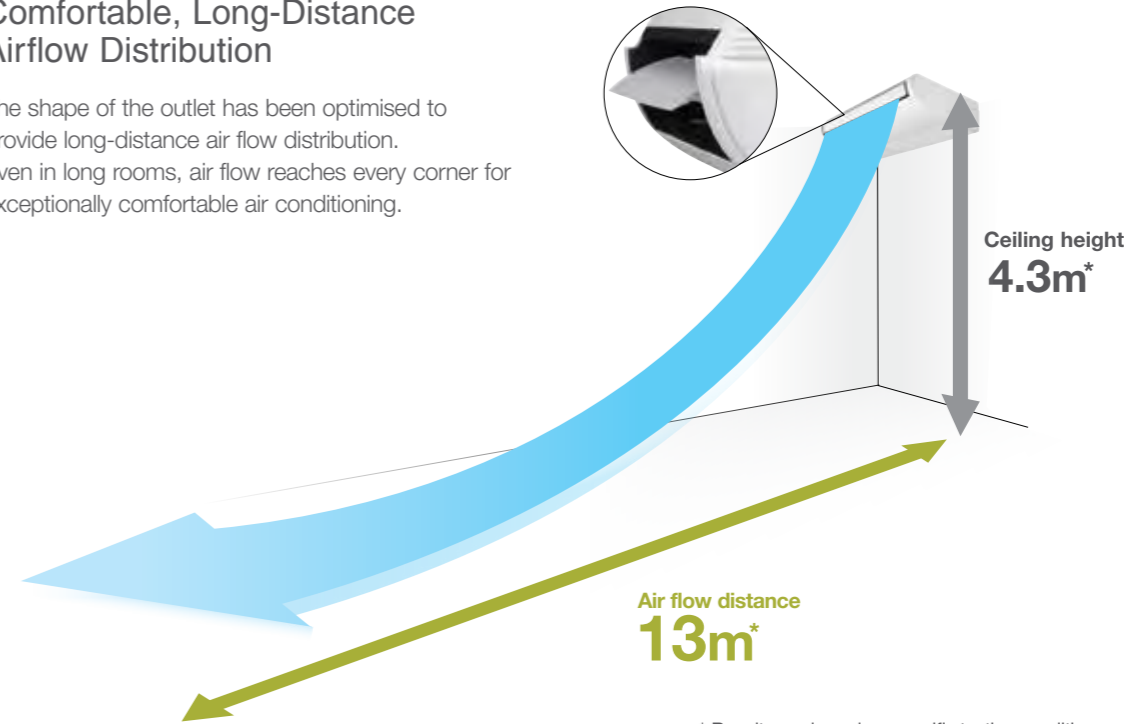

* Results are based on specific testing conditions

High Ceiling Setting *Setting by remote control	Air flow distance		
	100	125	140
4.3m	12m	13m	13m



Indoor Unit: Under Ceiling

Specifications of R32 Deluxe Model R32 REFRIGERANT

Capacity		7.1kW	10.0kW	12.5kW	14.0kW			
Model Name	Indoor Unit	S-71PT2E5B	S-100PT2E5B	S-100PT2E5B	S-125PT2E5B	S-125PT2E5B	S-140PT2E5B	S-140PT2E5B
	Outdoor Unit	U-71PZH2R5	U-100PZH2R5	U-100PZH2R8	U-125PZH2R5	U-125PZH2R8	U-140PZH2R5	U-140PZH2R8
Cooling capacity : Heating capacity	kW	7.1 (2.2 - 9.0) 8.0 (2.0 - 9.0)	10.0 (3.1 - 12.5) 11.2 (3.1 - 14.0)	10.0 (3.1 - 12.5) 11.2 (3.1 - 14.0)	12.5 (3.2 - 14.0) 14.0 (3.2 - 16.0)	12.5 (3.2 - 14.0) 14.0 (3.2 - 16.0)	14.0 (3.3 - 16.0) 16.0 (3.3 - 18.0)	14.0 (3.3 - 16.0) 16.0 (3.3 - 18.0)
	BTU/h	24,200 (7,500 - 30,700) 27,300 (6,800 - 30,700)	34,100 (10,600 - 42,700) 38,200 (10,600 - 47,800)	34,100 (10,600 - 42,700) 38,200 (10,600 - 47,800)	42,700 (10,900 - 47,800) 47,800 (10,900 - 54,600)	42,700 (10,900 - 47,800) 47,800 (10,900 - 54,600)	47,800 (11,300 - 54,600) 54,600 (11,300 - 61,400)	47,800 (11,300 - 54,600) 54,600 (11,300 - 61,400)
EER : COP	W/W	3.78 : 4.15	4.05 : 4.31	4.05 : 4.31	3.45 : 3.99	3.45 : 3.99	3.13 : 3.67	3.13 : 3.67
Total power input	Cooling : Heating	1.88 : 1.93	2.47 : 2.60	2.47 : 2.60	3.62 : 3.51	3.62 : 3.51	4.47 : 4.36	4.47 : 4.36
Indoor Unit								
Power source	Phase/Hz	1 Phase/ 50Hz	1 Phase/ 50Hz	1 Phase/ 50Hz	1 Phase/ 50Hz	1 Phase/ 50Hz	1 Phase/ 50Hz	1 Phase/ 50Hz
	V	230V 240V	230V 240V	230V 240V	230V 240V	230V 240V	230V 240V	230V 240V
Current	Cooling : Heating	A	0.44 : 0.44 0.43 : 0.43	0.67 : 0.67 0.65 : 0.65	0.67 : 0.67 0.65 : 0.65	0.86 : 0.86 0.83 : 0.83	0.86 : 0.86 0.83 : 0.83	0.91 : 0.91 0.88 : 0.88
Dimensions	H x W x D	mm	235 x 1,275 x 690	235 x 1,590 x 690	235 x 1,590 x 690	235 x 1,590 x 690	235 x 1,590 x 690	235 x 1,590 x 690
Net weight		kg	33	40	40	40	40	40
Air volume	Cooling : Heating	L/s	350 : 350	500 : 500	500 : 500	566 : 566	566 : 566	583 : 583
Sound pressure level (H/M/L)	Cooling : Heating	dB(A)	39 / 35 / 31 : 39 / 35 / 31	42 / 37 / 35 : 42 / 37 / 35	42 / 37 / 35 : 42 / 37 / 35	46 / 40 / 36 : 46 / 40 / 36	46 / 40 / 36 : 46 / 40 / 36	47 / 41 / 37 : 47 / 41 / 37
Sound power level (H/M/L)	Cooling : Heating	dB(A)	57 / 53 / 49 : 57 / 53 / 49	60 / 55 / 53 : 60 / 55 / 53	60 / 55 / 53 : 60 / 55 / 53	64 / 58 / 54 : 64 / 58 / 54	64 / 58 / 54 : 64 / 58 / 54	65 / 59 / 55 : 65 / 59 / 55
Number of fan speeds			3	3	3	3	3	3
Drain pipe size		mm	VP-20	VP-20	VP-20	VP-20	VP-20	VP-20
Outdoor Unit								
Power source	Phase/Hz	1 Phase/ 50Hz	1 Phase/ 50Hz	3 Phase/ 50Hz	1 Phase/ 50Hz	3 Phase/ 50Hz	1 Phase/ 50Hz	3 Phase/ 50Hz
	V	230V 240V	230V 240V	400V 415V	230V 240V	400V 415V	230V 240V	400V 415V
Current	Cooling : Heating	A	8.45 : 8.50 8.10 : 8.20	10.9 : 11.5 10.5 : 11.0	3.65 : 3.85 3.55 : 3.75	16.0 : 15.5 15.4 : 14.9	5.40 : 5.20 5.20 : 5.05	19.9 : 19.4 19.1 : 18.6
Dimensions	H x W x D	mm	996 x 940 x 340	1,416 x 940 x 340	1,416 x 940 x 340	1,416 x 940 x 340	1,416 x 940 x 340	1,416 x 940 x 340
Net weight		kg	68	99	99	99	99	99
Air volume	Cooling : Heating	L/s	1,017 : 1,000	1,967 : 1,800	1,967 : 1,800	2,083 : 1,867	2,083 : 1,867	2,150 : 1,933
Sound pressure level	Cooling : Heating	dB(A)	48 (46) : 50 (48)	52 (50) : 52 (50)	52 (50) : 52 (50)	53 (51) : 53 (51)	53 (51) : 53 (51)	54 (52) : 55 (53)
Sound power level	Cooling : Heating	dB(A)	64 (62) : 66 (64)	68 (66) : 68 (66)	68 (66) : 68 (66)	69 (67) : 69 (67)	69 (67) : 69 (67)	70 (68) : 70 (68)
Piping connections	Liquid / Gas	mm	Ø9.52 / Ø15.88	Ø9.52 / Ø15.88	Ø9.52 / Ø15.88	Ø9.52 / Ø15.88	Ø9.52 / Ø15.88	Ø9.52 / Ø15.88
Pipe length	min. - max.	m	5 - 50	5 - 85	5 - 85	5 - 85	5 - 85	5 - 85
Elevation difference (OU located lower, OU located higher)		m	15, 30	15, 30	15, 30	15, 30	15, 30	15, 30
Maximum chargeless length		m	30	30	30	30	30	30
Refrigerant at shipping / Additional gas amount		g	R32 1,950 / 45 (g/m)	R32 3,050 / 45 (g/m)	R32 3,050 / 45 (g/m)	R32 3,050 / 45 (g/m)	R32 3,050 / 45 (g/m)	R32 3,050 / 45 (g/m)
Operation ranges	Cooling : Heating	°C	-15 to 46 : -20 to 24	-15 to 46 : -20 to 24	-15 to 46 : -20 to 24	-15 to 46 : -20 to 24	-15 to 46 : -20 to 24	-15 to 46 : -20 to 24

Specifications of R32 Compact Model R32 REFRIGERANT

Capacity		6.0kW	7.1kW	10.0kW	12.5kW	14.0kW			
Model Name	Indoor Unit	S-60PT2E5B	S-71PT2E5B	S-100PT2E5B	S-100PT2E5B	S-125PT2E5B	S-140PT2E5B	S-140PT2E5B	
	Outdoor Unit	U-60PZ2R5	U-71PZ2R5	U-100PZ2R5	U-100PZ2R8	U-125PZ2R5	U-125PZ2R8	U-140PZ2R5	
Cooling capacity : Heating capacity	kW	6.0(2.0-7.1) 6.0(1.8-7.6)	7.1(2.0-8.0) 7.1(1.8-8.6)	10.0(3.0-11.5) 10.0(3.0-14.0)	10.0(3.0-11.5) 10.0(3.0-14.0)	12.5(3.2-13.5) 12.5(3.3-15.0)	12.5(3.2-13.5) 12.5(3.3-15.0)	13.6(3.3-15.0) 14.0(3.4-16.0)	13.6(3.3-15.0) 14.0(3.4-16.0)
	BTU/h	20,500 (6,800 - 24,200) 20,500 (6,100 - 25,900)	24,200 (6,800 - 27,300) 24,200 (6,800 - 29,300)	34,100 (10,200 - 39,200) 34,100 (10,200 - 47,800)	34,100 (10,200 - 39,200) 34,100 (10,200 - 47,800)	42,700 (10,900 - 46,100) 42,700 (11,300 - 51,200)	42,700 (10,900 - 46,100) 42,700 (11,300 - 51,200)	46,400 (11,300 - 51,200) 47,800 (11,600 - 54,600)	46,400 (11,300 - 51,200) 47,800 (11,600 - 54,600)
EER : COP	W/W	4.05 : 4.80 4.05 : 4.80	3.68 : 4.38 3.66 : 4.38	3.64 : 4.24 3.64 : 4.24	3.64 : 4.24 3.64 : 4.24	3.32 : 3.89 3.32 : 3.89	3.32 : 3.89 3.32 : 3.89	3.15 : 3.70 3.15 : 3.70	
Total power input	Cooling : Heating	1.48 : 1.25	1.93 : 1.62	2.75 : 2.36	2.75 : 2.36	3.76 : 3.21	3.76 : 3.21	4.32 : 3.78	
Indoor Unit									
Power source	Phase/Hz	1 Phase/ 50Hz	1 Phase/ 50Hz	1 Phase/ 50Hz	1 Phase/ 50Hz	1 Phase/ 50Hz	1 Phase/ 50Hz	1 Phase/ 50Hz	
	V	230V 240V	230V 240V	230V 240V	230V 240V	230V 240V	230V 240V	230V 240V	
Current	Cooling : Heating	A	0.41 : 0.41 0.40 : 0.40	0.44 : 0.44 0.43 : 0.43	0.67 : 0.67 0.65 : 0.65	0.67 : 0.67 0.65 : 0.65	0.86 : 0.86 0.83 : 0.83	0.86 : 0.86 0.83 : 0.83	
Dimensions	H x W x D	mm	235x1,275 x690	235 x 1,275 x 690	235 x 1,590 x 690	235 x 1,590 x 690	235 x 1,590 x 690	235 x 1,590 x 690	
Net weight		kg	33	33	40	40	40	40	
Air volume	Cooling : Heating	L/s	333 : 333	350 : 350	500 : 500	500 : 500	566 : 566	566 : 566	
Sound pressure level (H/M/L)	Cooling : Heating	dB(A)	38 / 34 / 30 : 38 / 34 / 30	39 / 35 / 31 : 39 / 35 / 31	42 / 37 / 35 : 42 / 37 / 35	42 / 37 / 35 : 42 / 37 / 35	46 / 40 / 36 : 46 / 40 / 36	46 / 40 / 36 : 46 / 40 / 36	
Sound power level (H/M/L)	Cooling : Heating	dB(A)	56 / 52 / 48 : 56 / 52 / 48	57 / 53 / 49 : 57 / 53 / 49	60 / 55 / 53 : 60 / 55 / 53	60 / 55 / 53 : 60 / 55 / 53	64 / 58 / 54 : 64 / 58 / 54	64 / 58 / 54 : 64 / 58 / 54	
Number of fan speeds			3	3	3	3	3	3	
Drain pipe size		mm	VP-20	VP-20	VP-20	VP-20	VP-20	VP-20	
Outdoor Unit									
Power source	Phase/Hz	1 Phase/ 50Hz	1 Phase/ 50Hz	1 Phase/ 50Hz	3 Phase/ 50Hz	1 Phase/ 50Hz	3 Phase/ 50Hz	1 Phase/ 50Hz	
	V	230V 240V	230V 240V	230V 240V	400V 415V	230V 240V	400V 415V	230V 240V	
Current	Cooling : Heating	A	6.90 : 5.80 6.60 : 5.55	8.95 : 7.55 8.60 : 7.25	12.2 : 10.4 11.7 : 10.0	4.15 : 3.55 4.00 : 3.40	16.9 : 14.3 16.2 : 13.7	5.60 : 4.75 5.40 : 4.60	
Dimensions	H x W x D	mm	695 x 875 x 320	695 x 875 x 320	996 x 980 x 370	996 x 980 x 370	996 x 980 x 370	996 x 980 x 370	
Net weight		kg	44	44	90	90	94	94	
Air volume	Cooling : Heating	L/s	750 : 750	867 : 750	1,285 : 1,169	1,285 : 1,169	1,436 : 1,302	1,436 : 1,386	
Sound pressure level	Cooling : Heating	dB(A)	46 (44) : 48 (46)	49 (47) : 49 (47)	52 (50) : 52 (50)	52 (50) : 52 (50)	55 (53) : 55 (53)	56 (54) : 56 (54)	
Sound power level	Cooling : Heating	dB(A)	65 (63) : 66 (64)	67 (65) : 67 (65)	68 (66) : 67 (65)	68 (66) : 67 (65)	70 (68) : 70 (68)	71 (69) : 71 (69)	
Piping connections	Liquid / Gas	mm	Ø9.52 / Ø15.88	Ø9.52 / Ø15.88	Ø9.52 / Ø15.88	Ø9.52 / Ø15.88	Ø9.52 / Ø15.88	Ø9.52 / Ø15.88	
Pipe length	min. - max.	m	3 - 40	3 - 40	5 - 50	5 - 50	5 - 50	5 - 50	
Elevation difference (OU located lower, OU located higher)		m	15, 30	15, 30	15, 30	15, 30	15, 30	15, 30	
Maximum chargeless length		m	30	30	30	30	30	30	
Refrigerant at shipping / Additional gas amount		g	R32 1,450 / 35 (g/m)	R32 1,450 / 35 (g/m)	R32 2,600 / 45 (g/m)	R32 2,600 / 45 (g/m)	R32 2,980 / 45 (g/m)	R32 2,980 / 45 (g/m)	
Operation ranges	Cooling : Heating	°C	-10 to 43 : -15 to 24	-10 to 43 : -15 to 24	-10 to 43 : -15 to 24	-10 to 43 : -15 to 24	-10 to 43 : -15 to 24	-10 to 43 : -15 to 24	

Notes:
 The Rated Capacity, Power Input and Running Current are measured in accordance with AS/NZS 3823
 • Cooling: Indoor temperature: 27°C DB/ 19°C WB, Outdoor temperature: 35°C DB/ 24°C WB
 • Heating: Indoor temperature: 20°C DB/ 15°C WB, Outdoor temperature: 7°C DB/ 6°C WB

Wall Mounted

Providing small, lightweight and low noise level design, it is ideal for small offices and other commercial applications. It also has a stylish smooth design with a washable front panel.

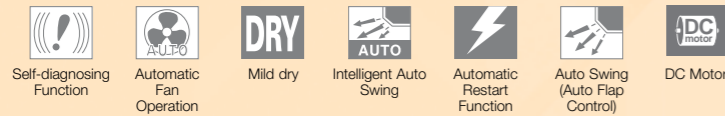

Technical focus

- Closed discharge port when not in use
- Lighter and smaller units make installation easy
- Quiet operation
- Smooth and durable design
- Piping outlet in six directions
- Washable front panel
- Air distribution is automatically altered depending on the operational mode of the unit

Closed discharge port

When the unit is turned off, the flap closes completely to prevent entry of dust into the unit and to keep the equipment clean.

Quiet operation

Low operating noise level makes these units ideal for hotels and hospital applications.

Piping outlet in six directions

Piping outlet is possible in the six directions of right, right rear, right bottom, left, left rear, left bottom, making installation easier.

Washable front panel

The indoor unit's front panel can be easily cleaned for trouble-free maintenance.



Air distribution is automatically adjusted depending on the operational mode of the unit

Air outlet angle is automatically adjusted for cooling and heating operation.

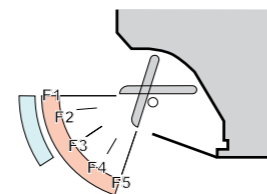

Heating: F1 to F5
Cooling: F1 to F3

Specifications R32

Capacity	9.5kW		9.0kW		
Model Name	Indoor Unit	S-100PK2E5B	S-100PK2E5B	S-100PK2E5B	S-100PK2E5B
	Outdoor Unit	U-100PZH2R5	U-100PZH2R8	U-100PZ2R5	U-100PZ2R8
Cooling capacity :	kW	9.5 (3.1 - 10.5)	9.5 (3.1 - 10.5)	9.0 (3.0 - 9.7)	9.0 (3.0 - 9.7)
		9.5 (3.1 - 11.5)	9.5 (3.1 - 11.5)	9.0 (3.0 - 10.5)	9.0 (3.0 - 10.5)
Heating capacity	BTU/h	32,400 (10,600 - 35,800)	32,400 (10,600 - 35,800)	30,700 (10,200 - 33,100)	30,700 (10,200 - 33,100)
		32,400 (10,600 - 39,200)	32,400 (10,600 - 39,200)	30,700 (10,200 - 35,800)	30,700 (10,200 - 35,800)
EER : COP	W/W	3.26 : 3.97	3.26 : 3.97	3.47 : 3.93	3.47 : 3.93
Total power input	Cooling : Heating kW	2.91 : 2.39	2.91 : 2.39	2.59 : 2.29	2.59 : 2.29
Indoor Unit					
Power source	Phase/Hz	1 Phase/ 50Hz	1 Phase/ 50Hz	1 Phase/ 50Hz	1 Phase/ 50Hz
	V	230V 240V	230V 240V	230V 240V	230V 240V
Current	Cooling : Heating A	0.68 : 0.68 0.66 : 0.66	0.68 : 0.68 0.66 : 0.66	0.68 : 0.68 0.66 : 0.66	0.68 : 0.68 0.66 : 0.66
Dimensions	H x W x D	302 x 1,120 x 236	302 x 1,120 x 236	302 x 1,120 x 236	302 x 1,120 x 236
Net weight	kg	14	14	14	14
Air volume	Cooling : Heating L/s	367 / 308 / 250 : 367 / 308 / 250	367 / 308 / 250 : 367 / 308 / 250	367 / 308 / 250 : 367 / 308 / 250	367 / 308 / 250 : 367 / 308 / 250
Sound pressure level (H/M/L)	Cooling : Heating dB(A)	49 / 45 / 41 : 49 / 45 / 41	49 / 45 / 41 : 49 / 45 / 41	49 / 45 / 41 : 49 / 45 / 41	49 / 45 / 41 : 49 / 45 / 41
Sound power level (H/M/L)	Cooling : Heating dB(A)	65 / 61 / 57 : 65 / 61 / 57	65 / 61 / 57 : 65 / 61 / 57	65 / 61 / 57 : 65 / 61 / 57	65 / 61 / 57 : 65 / 61 / 57
Number of fan speeds		5	5	5	5
Drain pipe size	mm	VP-16	VP-16	VP-16	VP-16
Outdoor Unit					
Power source	Phase/Hz	1 Phase/ 50Hz	3 Phase/ 50Hz	1 Phase/ 50Hz	3 Phase/ 50Hz
	V	230V 240V	400V 415V	230V 240V	400V 415V
Current	Cooling : Heating A	12.9 : 10.6 12.4 : 10.1	4.35 : 3.55 4.20 : 3.45	11.5 : 10.1 11.0 : 9.7	3.90 : 3.45 3.75 : 3.30
Dimensions	H x W x D	1,416 x 940 x 340	1,416 x 940 x 340	996 x 980 x 370	996 x 980 x 370
Net weight	kg	99	99	90	90
Air volume	Cooling : Heating L/s	1,967 : 1,800	1,967 : 1,800	1,285 : 1,169	1,285 : 1,169
Sound pressure level (Silent mode)	Cooling : Heating dB(A)	52 (50) : 52 (50)	52 (50) : 52 (50)	52 (50) : 52 (50)	52 (50) : 52 (50)
Sound power level (Silent mode)	Cooling : Heating dB(A)	68 (66) : 68 (66)	68 (66) : 68 (66)	68 (66) : 67 (65)	68 (66) : 67 (65)
Piping connections	Liquid / Gas	mm	Ø9.52 / Ø15.88	Ø9.52 / Ø15.88	Ø9.52 / Ø15.88
Pipe length	min. - max.	m	5 - 85	5 - 85	5 - 50
Elevation difference (OU located lower, OU located higher)	m	15, 30	15, 30	15, 30	15, 30
Maximum chargeless length	m	30	30	30	30
Refrigerant at shipping / Additional gas amount	g	R32 3,050 / 45 (g)	R32 3,050 / 45 (g)	R32 2,600 / 45 (g/m)	R32 2,600 / 45 (g/m)
Operation ranges	Cooling : Heating °C	-15 to 46 : -20 to 24	-15 to 46 : -20 to 24	-10 to 43 : -15 to 24	-10 to 43 : -15 to 24

Notes:
The Rated Capacity, Power Input and Running Current are measured in accordance with AS/NZS 3823
• Cooling: Indoor temperature: 27°C DB/ 19°C WB, Outdoor temperature: 35°C DB/ 24°C WB
• Heating: Indoor temperature: 20°C DB/ 15°C WB, Outdoor temperature: 7°C DB/ 6°C WB

Indoor Unit Dimensions

HIGH STATIC PRESSURE DUCTED

Dimensions (6.0kW – 16.0kW)

S-60PE1R5B / S-71PE1R5B / S-100PE1R5B / S-125PE1R5B / S-140PE1R5B

- 1 Refrigerant liquid tubing (Flare) $\phi 9.52$
- 2 Refrigerant gas tubing (Flare) $\phi 15.88$
- 3 Air intake duct connecting side flange
- 4 Air discharge duct connecting side flange
- 5 Drain port

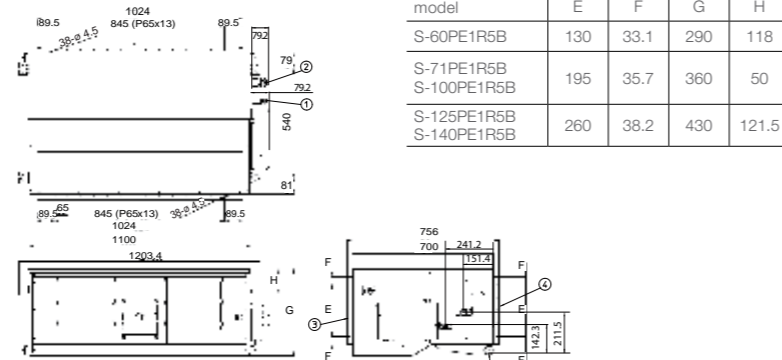

model	E	F	G	H
S-60PE1R5B	130	33.1	290	118
S-71PE1R5B S-100PE1R5B	195	35.7	360	50
S-125PE1R5B S-140PE1R5B	260	38.2	430	121.5

unit: mm

S-160PE1R5B

- 1 Refrigerant liquid tubing (Flare) $\phi 9.52$
- 2 Refrigerant gas tubing (Brazing) $\phi 19.05$
- 3 Air intake duct connecting side flange
- 4 Air discharge duct connecting side flange
- 5 Drain port

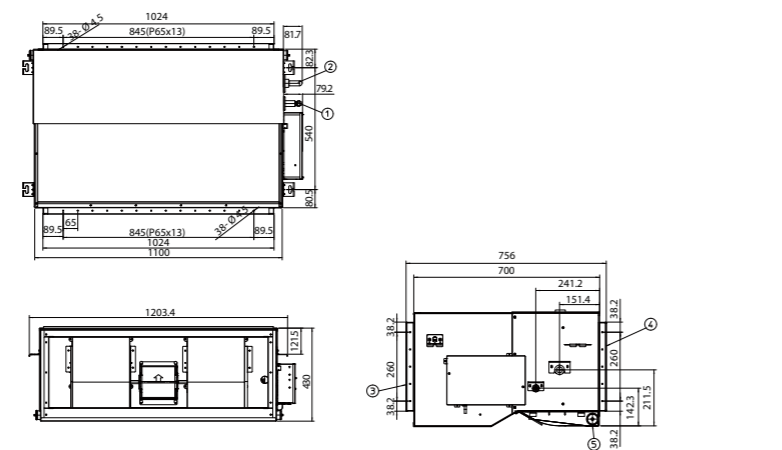

unit: mm

HIGH STATIC PRESSURE SPLITTABLE DUCTED

Dimensions (18.0kW – 22.4kW)

S-180PE3R5B / S-200PE3R5B / S-224PE3R5B

- 1 Refrigerant liquid tubing (Flare)
Type 180 : $\phi 9.52$
Type 200/224 : $\phi 12.7$
- 2 Refrigerant gas tubing (Brazing)
 $\phi 19.05$
(Type 180 (50 - 75m) : Connection tubing $\phi 19.05 \rightarrow \phi 25.4$
Type 200/224 (30 - 60m) : Connection tubing $\phi 19.05 \rightarrow \phi 25.4$)
- 3 Power supply port
- 4 Communication port
- 5 Drain port 25A
- 6 Air intake duct connecting side flange
- 7 Air discharge duct connecting side flange

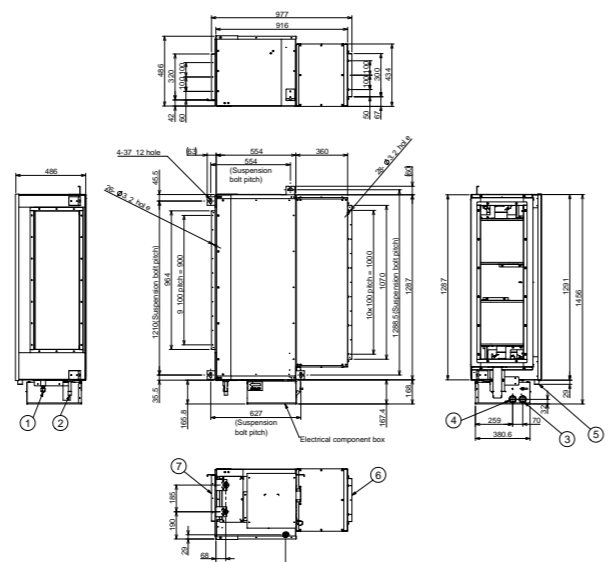

unit: mm

HIGH STATIC PRESSURE SLIM-LINE DUCTED

Dimensions (6.0kW – 7.1kW)

S-60PF1E5B / S-71PF1E5B

- 1 Refrigerant piping joint (liquid tube) $\phi 9.52$ Flare
- 2 Refrigerant piping joint (gas tube) $\phi 15.88$ Flare
- 3 Upper drain port VP25 (O.D. $\phi 32$ mm)
- 200 flexible hose supplied
- 4 Bottom drain port VP25 (O.D. $\phi 32$ mm)
- 5 Suspension lug (4-12 x 30 mm)
- 6 Power supply outlet
- 7 Fresh air intake port ($\phi 150$ mm)
- 8 Flange for flexible air outlet duct
- 9 Electrical component box

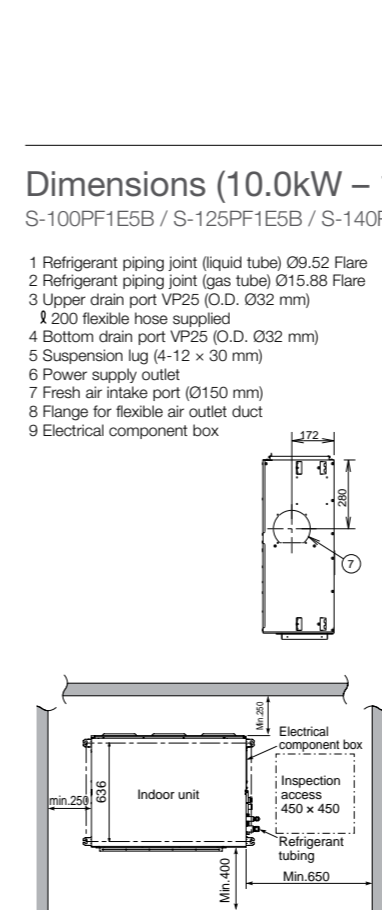
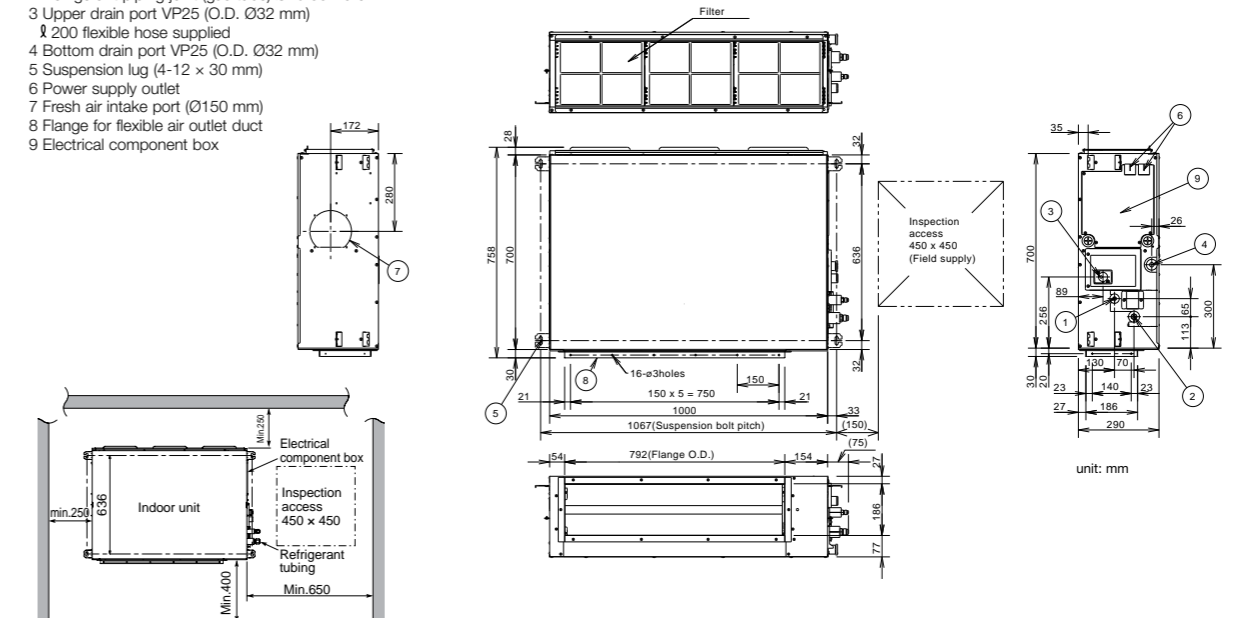

Dimensions (10.0kW – 14.0kW)

S-100PF1E5B / S-125PF1E5B / S-140PF1E5B

- 1 Refrigerant piping joint (liquid tube) $\phi 9.52$ Flare
- 2 Refrigerant piping joint (gas tube) $\phi 15.88$ Flare
- 3 Upper drain port VP25 (O.D. $\phi 32$ mm)
- 200 flexible hose supplied
- 4 Bottom drain port VP25 (O.D. $\phi 32$ mm)
- 5 Suspension lug (4-12 x 30 mm)
- 6 Power supply outlet
- 7 Fresh air intake port ($\phi 150$ mm)
- 8 Flange for flexible air outlet duct
- 9 Electrical component box

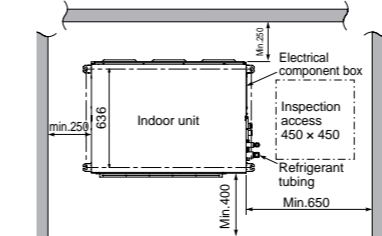
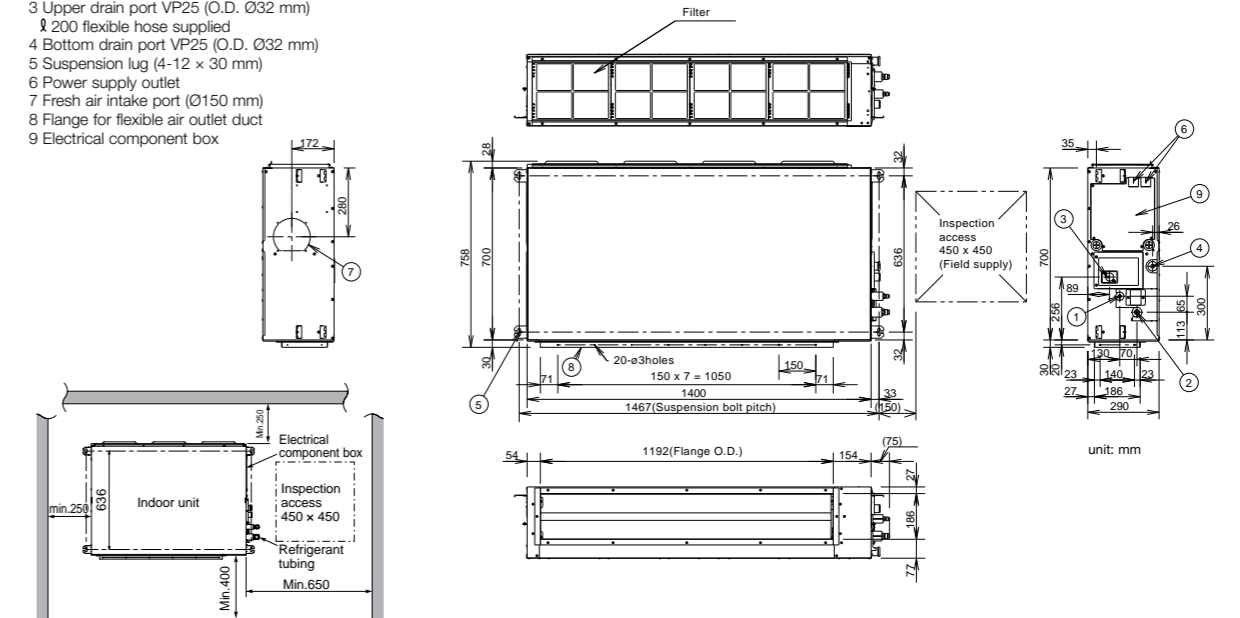

Products for Small Sized Project

Product line-up suitable for light to medium commercial and residential applications.



Ultra Slim Ducted

CS-Z25UD3RAW
CS-Z35UD3RAW
CS-Z50UD3RAW
CS-Z60UD3RAW



4-WAY Mini Cassette

CS-Z25UB4RAW
CS-Z35UB4RAW
CS-Z50UB4RAW
CS-Z60UB4RAW



CU-Z25UBRA



CU-Z35UBRA



CU-Z50UBRA
CU-Z60UBRA



CZ-RD52CP
(optional for
4-WAY Mini Cassette)



CZ-TACG1**
(optional)

Panel
CZ-BT30EW

Ultra Slim Ducted



Technical focus

- WLAN Control Possible (CZ-TACG1 is needed)
- Market-leading Energy Efficiency
- Only 200mm High
- Rear or Bottom Return Air Options
- Built-in Drain Pump
- -15°C to +46°C Operating Range

Specifications

		Ultra Slim Ducted			
Capacity		2.6KW	3.7KW	5.0KW	5.6KW
model Name	Indoor Unit	CS-Z25UD3RAW	CS-Z35UD3RAW	CS-Z50UD3RAW	CS-Z60UD3RAW
	Outdoor Unit	CU-Z25UBRA	CU-Z35UBRA	CU-Z50UBRA	CU-Z60UBRA
Cooling capacity :	kW	2.60 (0.85 - 3.20) 3.30 (0.85 - 4.90)	3.70 (0.85 - 4.00) 4.20 (0.85 - 5.60)	5.00 (0.90 - 5.70) 6.10 (0.90 - 7.20)	5.60 (0.90 - 6.50) 7.00 (0.90 - 8.00)
	BTU/h	8,870 (2,900 - 10,900) 11,300 (2,900 - 16,700)	12,600 (2,900 - 13,600) 14,300 (2,900 - 19,100)	17,100 (3,070 - 19,400) 20,800 (3,070 - 24,600)	19,100 (3,070 - 22,200) 23,900 (3,070 - 27,300)
EER : COP	W/W	4.48 : 4.23	3.85 : 4.08	3.57 : 3.63	3.29 : 3.24
Power input (min - max)	Cooling : Heating kW	0.58 (0.24 - 0.85) : 0.78 (0.23 - 1.25)	0.96 (0.24 - 1.12) : 1.03 (0.23 - 1.57)	1.40 (0.26 - 1.78) : 1.68 (0.26 - 2.20)	1.70 (0.26 - 2.30) : 2.16 (0.26 - 2.60)
Indoor Unit					
Power source	Phase/Hz	1 Phase/ 50Hz	1 Phase/ 50Hz	1 Phase/ 50Hz	1 Phase/ 50Hz
	V	230V 240V	230V 240V	230V 240V	230V 240V
Current	Cooling : Heating A	2.80 : 3.50 2.70 : 3.40	4.30 : 4.70 4.20 : 4.50	6.30 : 7.40 6.10 : 7.20	7.50 : 9.50 7.30 : 9.30
Dimensions	H x W x D mm	200 x 750 x 640	200 x 750 x 640	200 x 750 x 640	200 x 750 x 640
Net weight	kg	19	19	19	19
Air volume	Cooling : Heating L/s	175 : 175	187 : 187	255 : 255	262 : 262
Sound pressure level (H/M/L)	Cooling : Heating dB(A)	33 / 27 / 24 : 34 / 27 / 24	33 / 26 / 23 : 35 / 27 / 24	39 / 29 / 26 : 39 / 30 / 27	41 / 30 / 27 : 41 / 32 / 29
Sound power level (H/M/L)	Cooling : Heating dB(A)	49 / 43 / 40 : 50 / 43 / 40	49 / 42 / 39 : 51 / 43 / 40	55 / 45 / 42 : 55 / 46 / 43	57 / 46 / 43 : 57 / 48 / 45
Outdoor Unit					
Power source	Phase/Hz	1 Phase / 50Hz	1 Phase / 50Hz	1 Phase / 50Hz	1 Phase / 50Hz
	V	230V 240V	230V 240V	230V 240V	230V 240V
Dimensions	H x W x D mm	542 x 780 x 289	619 x 824 x 299	695 x 875 x 320	695 x 875 x 320
Net weight	kg	33	35	42	43
Piping connections	Liquid / Gas mm	Ø6.35 / Ø9.52	Ø6.35 / Ø9.52	Ø6.35 / Ø12.70	Ø6.35 / Ø12.70
Pipe length	min. - max. m	3 - 20	3 - 20	3 - 30	3 - 30
Elevation difference	m	15	15	20	20
Operation ranges	Cooling : Heating °C	-10 ~ +46 : -15 ~ +24	-10 ~ +46 : -15 ~ +24	-10 ~ +46 : -15 ~ +24	-10 ~ +46 : -15 ~ +24

Notes:
The Rated Capacity, Power Input and Running Current are measured in accordance with AS/NZS 3823
• Cooling: Indoor temperature: 27°C DB/ 19°C WB, Outdoor temperature: 35°C DB/ 24°C WB
• Heating: Indoor temperature: 20°C DB/ 15°C WB, Outdoor temperature: 7°C DB/ 6°C WB
* Products for Small Sized Project above (Ultra Slim Ducted and 4-WAY Mini Cassette) are not supported by PAC Smart Connectivity+ and Panasonic AC Smart Cloud.
**If you connect WLAN adaptor (CZ-TACG1) to an indoor unit other than wall mounted type and operate from the smartphone with Panasonic Comfort Cloud App, airflow direction may not be operated as it is shown on the display.

4-WAY Mini Cassette

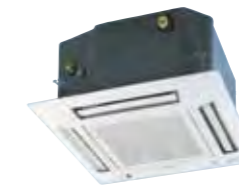

Technical focus

- WLAN Control Possible (CZ-TACG1 is needed)
- Market-leading Energy Efficiency
- Compact Design (260mm High)
- Easy Installation
- Built-in Drain Pump
- -15°C to +46°C Operating Range

Specifications

Mini Cassette			
2.5KW	3.5KW	4.8KW	5.7KW
CS-Z25UB4RAW	CS-Z35UB4RAW	CS-Z50UB4RAW	CS-Z60UB4RAW
CU-Z25UBRA	CU-Z35UBRA	CU-Z50UBRA	CU-Z60UBRA
2.50 (0.85 - 3.20) 3.20 (0.85 - 4.80)	3.50 (0.85 - 4.00) 4.00 (0.85 - 5.40)	4.80 (0.90 - 5.70) 5.00 (0.90 - 7.10)	5.70 (0.90 - 6.35) 6.00 (0.90 - 8.00)
8,530 (2,900 - 10,900) 10,900 (2,900 - 16,400)	11,900 (2,900 - 13,600) 13,600 (2,900 - 18,400)	16,400 (3,070 - 19,400) 17,100 (3,070 - 24,200)	19,400 (3,070 - 21,700) 20,500 (3,070 - 27,300)
4.55 : 4.16 0.55 (0.24 - 0.82) : 0.77 (0.23 - 1.32)	3.89 : 3.92 0.90 (0.24 - 1.18) : 1.02 (0.23 - 1.65)	3.38 : 3.38 1.42 (0.26 - 1.84) : 1.48 (0.26 - 2.41)	3.29 : 3.30 1.73 (0.26 - 2.20) : 1.82 (0.26 - 2.75)
1 Phase/ 50Hz 230V 240V	1 Phase/ 50Hz 230V 240V	1 Phase/ 50Hz 230V 240V	1 Phase/ 50Hz 230V 240V
2.60 : 3.50 2.50 : 3.40	4.05 : 4.55 3.95 : 4.35	6.30 : 6.50 6.10 : 6.30	7.60 : 8.00 7.40 : 7.80
260 x 575 x 575 18 175 : 180	260 x 575 x 575 18 175 : 195	260 x 575 x 575 18 192 : 197	260 x 575 x 575 18 237 : 253
34 / 25 / 22 : 35 / 28 / 25 50 / 41 / 38 : 51 / 44 / 41	34 / 26 / 23 : 37 / 28 / 25 50 / 42 / 39 : 53 / 44 / 41	38 / 28 / 25 : 39 / 29 / 26 54 / 44 / 41 : 55 / 45 / 42	43 / 32 / 29 : 45 / 32 / 29 59 / 48 / 45 : 61 / 48 / 45
1 Phase / 50Hz 230V 240V	1 Phase / 50Hz 230V 240V	1 Phase / 50Hz 230V 240V	1 Phase / 50Hz 230V 240V
542 x 780 x 289 33 Ø6.35 / Ø9.52	619 x 824 x 299 35 Ø6.35 / Ø9.52	695 x 875 x 320 42 Ø6.35 / Ø12.70	695 x 875 x 320 43 Ø6.35 / Ø12.70
3 - 20 15 -10 ~ +46 : -15 ~ +24	3 - 20 15 -10 ~ +46 : -15 ~ +24	3 - 30 20 -10 ~ +46 : -15 ~ +24	3 - 30 20 -10 ~ +46 : -15 ~ +24

Notes:
The Rated Capacity, Power Input and Running Current are measured in accordance with AS/NZS 3823
• Cooling: Indoor temperature: 27°C DB/ 19°C WB, Outdoor temperature: 35°C DB/ 24°C WB
• Heating: Indoor temperature: 20°C DB/ 15°C WB, Outdoor temperature: 7°C DB/ 6°C WB

Small Sized Project Dimensions

OUTDOOR UNIT

Dimensions (2.5kW – 2.6kW)
CU-Z25UBRA

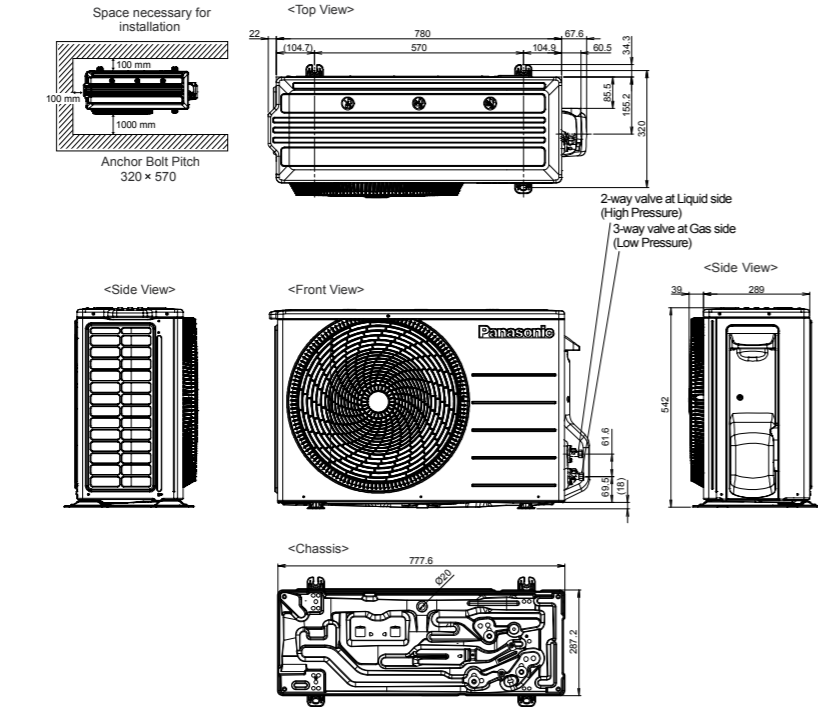

unit: mm

Dimensions (4.8kW – 5.7kW)
CU-Z50UBRA / CU-Z60UBRA

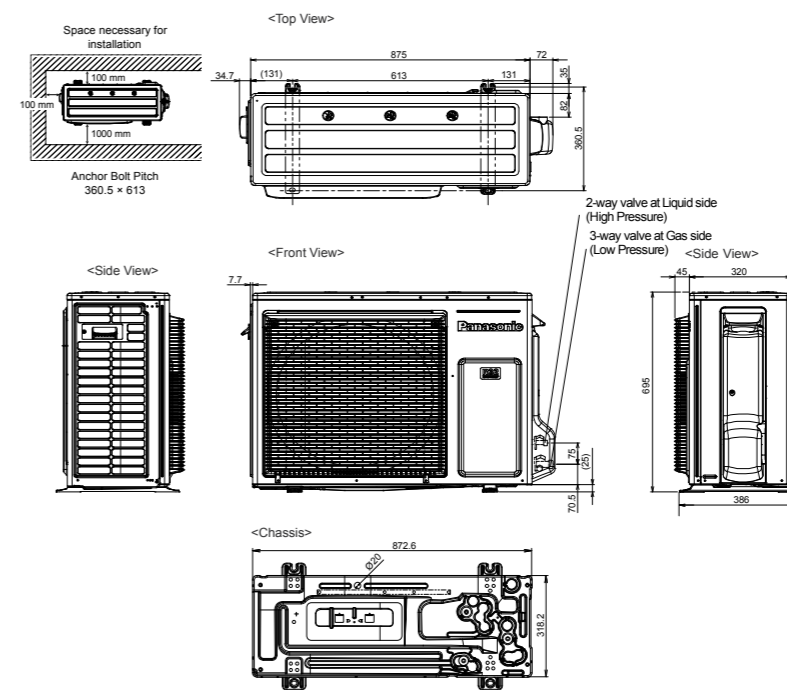

unit: mm

Dimensions (3.5kW – 3.7kW)
CU-Z35UBRA

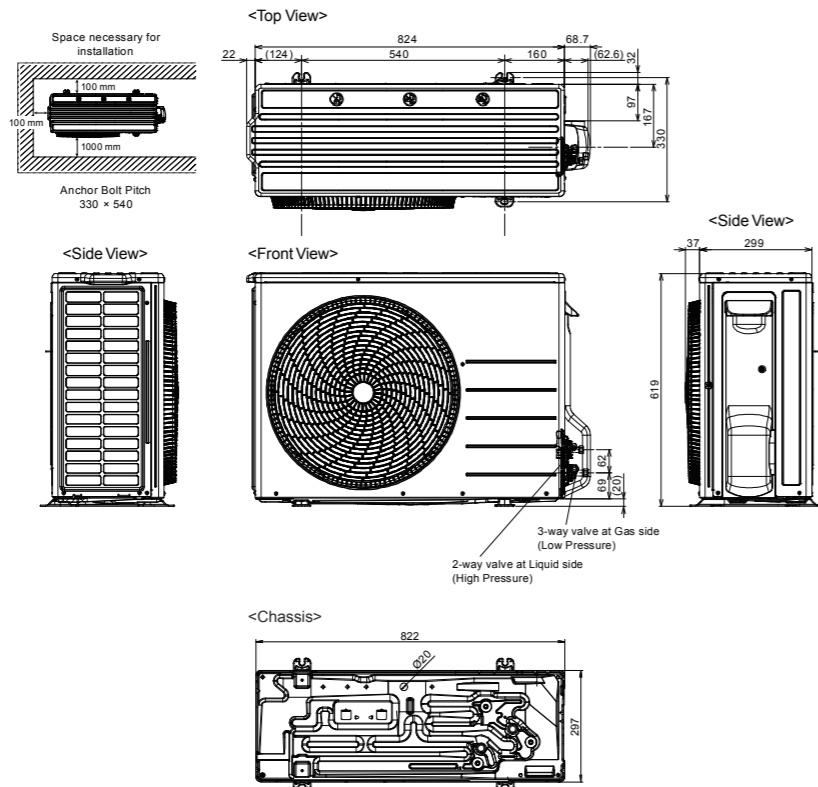

unit: mm

Small Sized Project Dimensions

ULTRA SLIM DUCTED

Dimensions (2.6kW – 5.6kW)

CS-Z25UD3RAW / CS-Z35UD3RAW / CS-Z50UD3RAW / CS-Z60UD3RAW

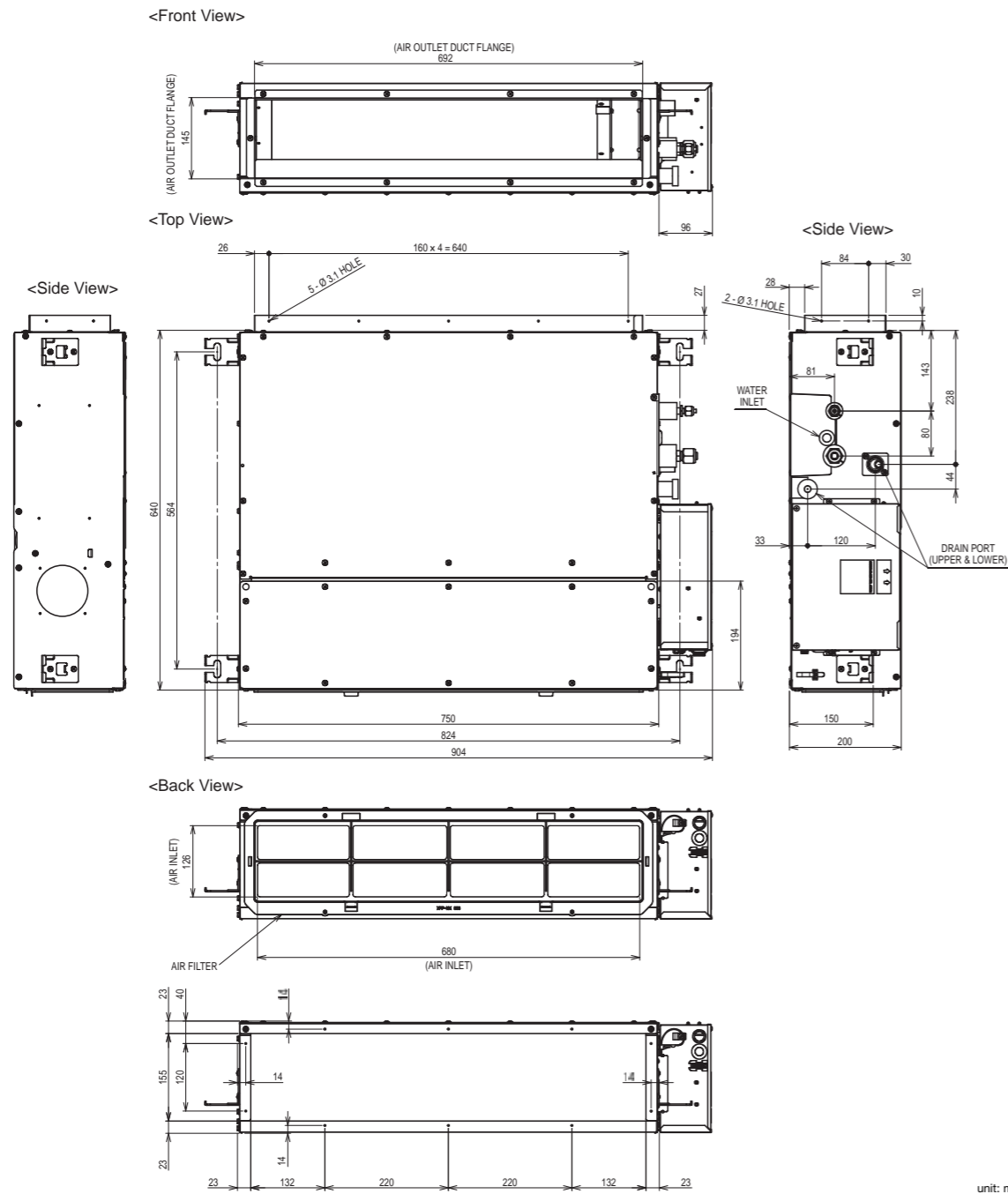

unit: mm

4-WAY MINI CASSETTE

Dimensions (2.5kW – 5.7kW)

CS-Z25UB4RAW / CS-Z35UB4RAW / CS-Z50UB4RAW / CS-Z60UB4RAW

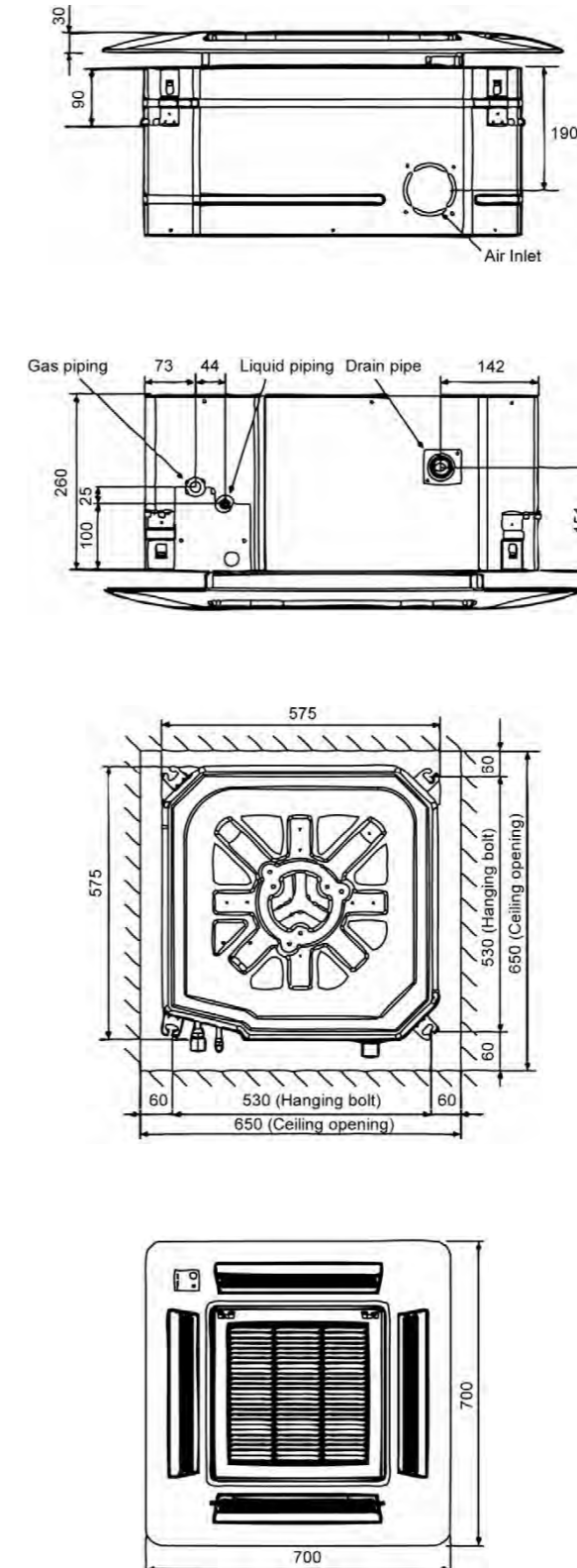

unit: mm

Smart Connectivity and Control Solutions

Panasonic offers a range of smart connectivity and control solutions for residential and commercial applications that allows you to conveniently manage and monitor air conditioning units in single or multiple locations from one mobile device.



Wide Range of Smart Control Solutions for All Needs

Whether you need to control multiple sites, a single office, or your home, we offer a range of innovative smart control solutions for a variety of needs.



Panasonic Comfort Cloud

Intuitive and scalable air conditioning control solution using a personal mobile device.



PAC Smart Connectivity+

Offers efficient energy management with high indoor air quality (IAQ) control.



Panasonic AC Smart Cloud

Monitor and manage energy consumption of multiple location through a cloud computing system.

For Residential

Panasonic Comfort Cloud Home Automation Ready

Personal Control Solutions Panasonic Comfort Cloud

- Remotely manage and monitor multiple air conditioning units in your home**
Easily control and access all features of the air conditioning units with smart centralised control.
- Intuitive voice control**
Control air conditioning units by voice command connecting to smart speaker.



PLUG & PLAY FOR HOME AUTOMATION

Easily connect with integrated controllers to become part of your automated home network.



For further information, please check PUSH and CLIPSAL® website.

For Light Commercial

Panasonic Comfort Cloud **PAC Smart Connectivity+**

Cost effective Energy Management Solution



- Multiple location control at your convenience with Comfort Cloud**
Gain control of multiple zones and sites intuitively adjusting temperature by areas with differentiated user rights settings.
- Indoor Air Quality (IAQ) and efficient energy usage with PAC Smart Connectivity+**
 - Ultimate cooling comfort with sensing technology and automatic IAQ control.
 - Simplified Plug & Play installation with BMS connection for better energy consumption.

For Multiple Building Management

Panasonic AC Smart Cloud

Full Control of All Installations From A Single Internet Connection Panasonic AC Smart Cloud

- Manage and monitor energy consumption patterns**
Analyse energy usage, running time and optimise temperatures to reduce energy costs.
- Centralised control solution with zero downtime**
Receive real-time status updates to prevent breakdowns.
- Flexible and scalable solution for expanding businesses and multi sites**
Adaptable solutions that can easily be upgraded for new features, meet user demand and better IT management.

Panasonic Comfort Cloud

Control air conditioning units from wherever and whenever with your smartphone, by using Panasonic Comfort Cloud and WLAN smart adaptor.

This scalable solution is ideal for one system, one site or multiple locations. Coupling the adaptor with the already feature rich systems, makes it an ideal solution for both residential and commercial applications.



For Residential

Remotely manage and monitor air conditioning units from anywhere anytime.

For Light Commercial

Gain control of multiple zones and sites intuitively up to 200 indoor units.

Panasonic Comfort Cloud features

Voice Control

Control air conditioning units by voice command intuitively connecting to smart speaker.*1



Multiple User

The Panasonic Comfort Cloud App allows multiuser access control. Restrict user access to specific units.



From 1 to 200 units

User can control up to 200 indoor units. 10 different sites, with up to 20 units / groups per site.



Energy Monitor

See the estimated power consumption and compare with other periods to see how energy bill can be reduced even more.*2

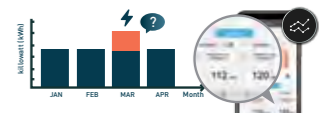

Easy Scheduling

Complex weekly scheduling made simple. Not only for one units, but across multiple sites and from a smartphone.

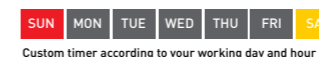

Error Codes

Error code notification through the App, provides early notification and allows for faster repair.



Application Examples



Centralised control from reception.

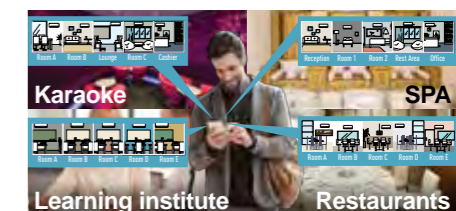

Multiple location control for small business.

System configuration

Network Adaptor
CZ-TACG1 CZ-CAPWFC1



Connection Diagram



Indoor Unit

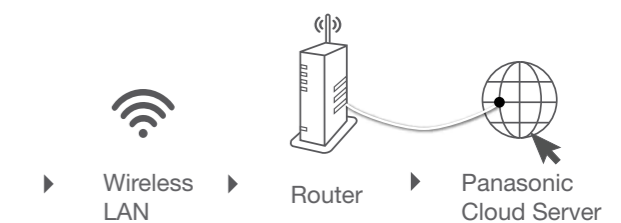

Wireless LAN
In conformity with IEEE 802.11

CZ-TACG1: For products for small sized project. (Page 40-41)
CZ-CAPWFC1: Available for all types of VRF and PAC indoor unit.

WLAN Smart Adaptor specification

	CZ-TACG1	CZ-CAPWFC1
Input Voltage	DC 1.2V (Supplied from indoor unit)	
Power Consumption	Maximum 0.66W	Maximum 2.4W
Size [H x W x D]	66 x 36 x 12mm	120 x 70 x 25mm
Weight	Approx. 85g	190g (including communications lines)
Interface	Wireless LAN	
Wireless LAN Standard	IEEE 802.11 b/g/n	
Frequency range	2.4GHz band	
Encryption	WPA2-PSK(TKIP/AES)	
Operation range	0-55°C, 20 - 80RH%	



Comfort Cloud App

Compatible Device and Browsers

1. IOS 9.0 or above
2. Android 4.4 or above

*1 Time of release in Quarter Three 2019.
CZ-TACG1 or CZ-CAPWFC1 Network Adaptor required per unit.
Requires an Internet connection and the App downloaded from the App Store or GooglePlay Store on your smartphone or tablet with the latest Operating System available.
To use Amazon Alexa to control your air conditioner, you will need an Amazon Echo device.
To use Google Assistant to control your air conditioner, you will need a Google Assistant device.
Google is a trademark of Google LLC.
Amazon, Alexa and all related logos are trademarks of Amazon.com, Inc. or its affiliates.
*2 Function available depending on the model.

Plug & Play for Home Automation

Easily connect with integrated controllers to become part of your automated home network. Plug & Play with Push controls and Clipsal solutions to enjoy simplicity you've been waiting for, empowering you to take control of your home's technology.

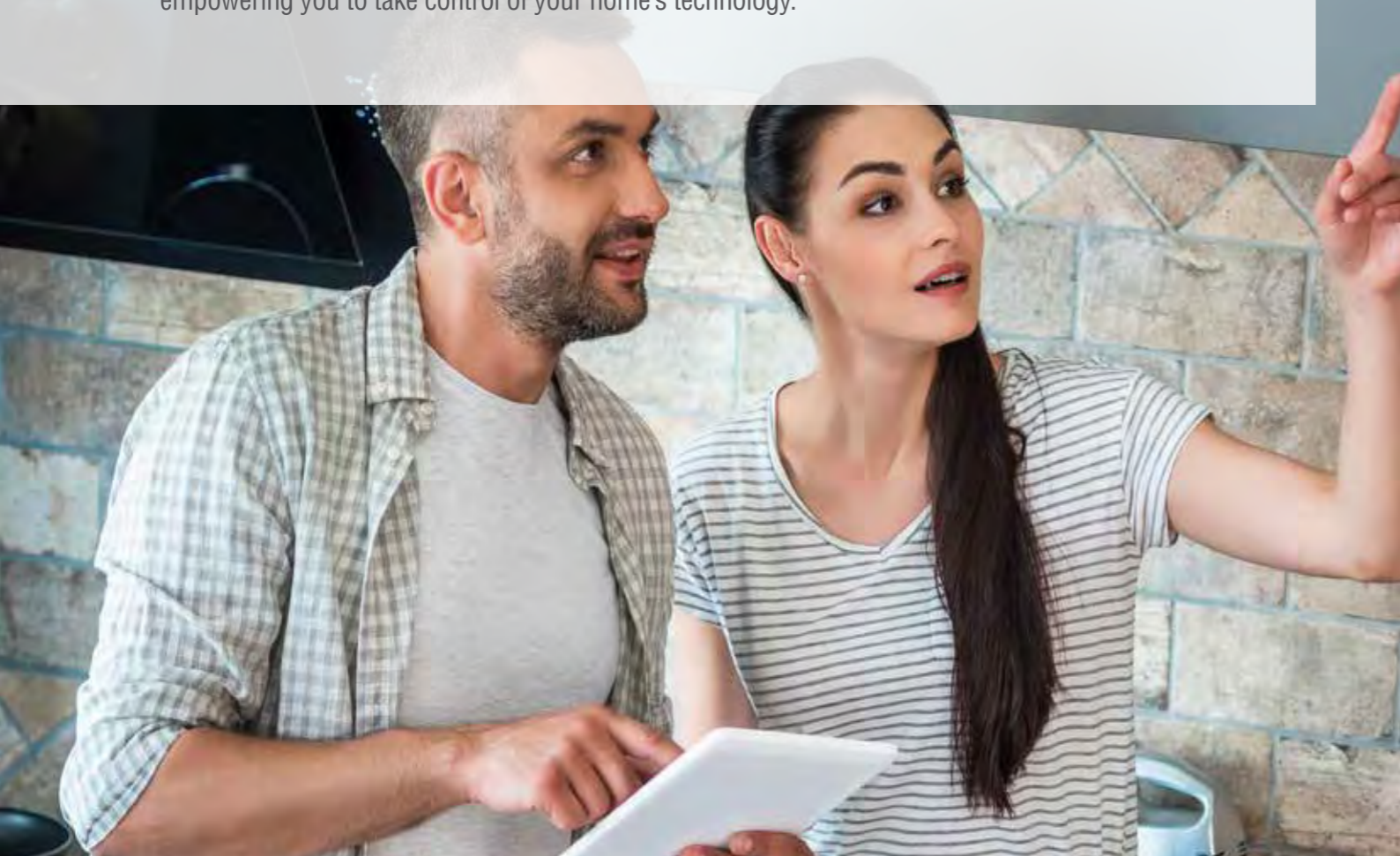

Easy Design / Plug & Play

Push Controls brings you smart home technologies and enables you to control devices at your fingertips from any smart phone or tablet. Panasonic air conditioners are ready for this smart home automation with just plug-and-play connectivity.

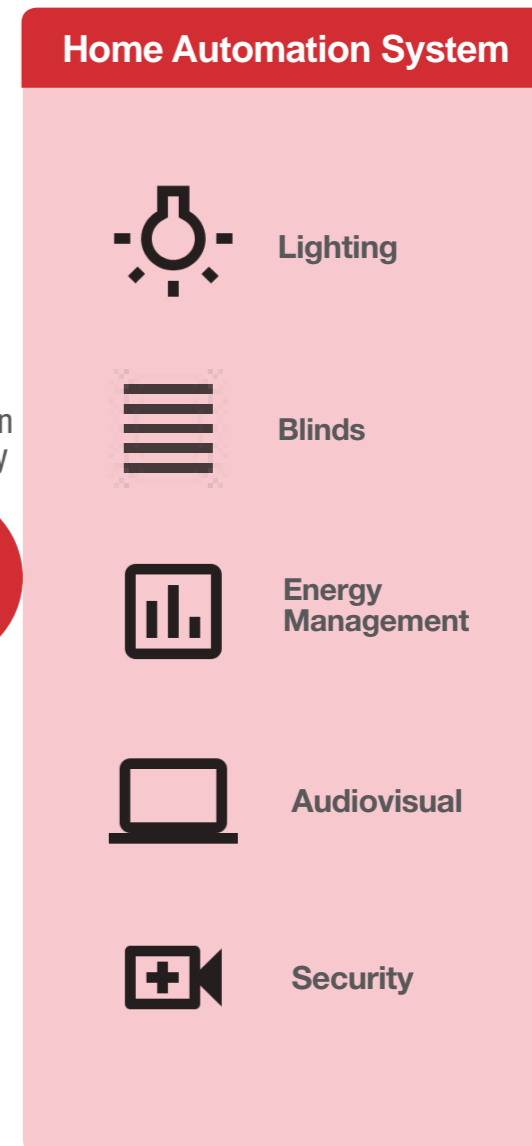
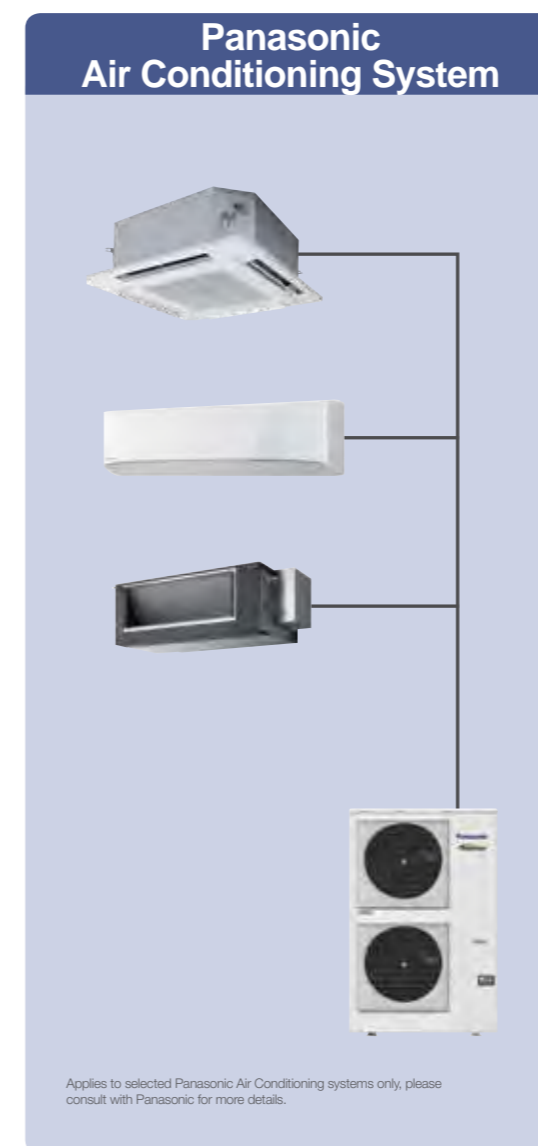

Panasonic partnering with Schneider Electric offering home automation solution with PUSH and CLIPSAL interfaces and devices.

Possible Climate Control

- Temperature point setting
- Mode setting
- Fan speed setting
- Room temperature feedback
- Error codes
- Control prohibition



For further information please check PUSH™ and CLIPSAL® website.

PAC Smart Connectivity+

Through thorough energy management, Panasonic's PAC Smart Connectivity+ is a completely new, state-of-the-art solution providing energy saving and comfort as well as simple installation, operation and maintenance.



PAC Smart Connectivity+ ~New SE8000 series~

1. Quality Air Control

Optimum IAQ is realized using the CO₂ & humidity sensors. The interior remains comfortable, while heating and cooling costs are minimized.

The CO₂ sensor controls ventilation systems which contributes to improving the room's air quality.



2. Room Key Card or Key Cardless Solutions for Hotels

Solutions are provided that meet the needs of various regions and hotel grades.

Whilst the previous model's automatic detection function offered optimal air conditioning with or without a hotel room key card, the latest model enables conventional key cards to control air conditioners and other devices coordinately. The increase in the types of devices that can be connected enables customized control of any hotel room.

3. Other Equipment Control

One room controller manages various devices including lighting and the blinds. A ventilation system and other external connection devices (dry contact input) can be connected by using HRC* or TE2 so that various control is possible with this controller alone, even without BMS.



*Available through a Schneider Electric distribution channel.

PAC Smart Connectivity+

PAC Smart Connectivity+ offers efficient energy management and a new air conditioning control solution with high IAQ (Indoor Air Quality).

Energy Management System for Rooms

Each room is monitored by high-precision sensors, making it possible to make every room's temperature comfortable without wasting energy.

Management System for the Entire Building

A Building Energy Management System (BMS) can also be connected for Plug & Play centralised control of the building's entire energy consumption.

Advantages



Dramatic Reduction of OpEx with Outstanding IAQ.

- 3 Built-in sensors: Temperature, RH and Occupancy
- ZigBee wireless sensors: CO₂/Temperature/RH%, window/door, ceiling/wall



Ultimate Customisation.

- Background colour customisable
- Custom display/icons, messages
- Programmable logic (also stand alone)
- Various controls and various external connection devices



User-/Owner-friendly.

- Colour touch screen
- Ease and simply of use
- 22 Languages
- Easy-to-understand error description



Easy Design and Plug and Play to Reduce CapEx.

- Simple Plug & Play connection to Building Energy Management System (BMS)
- Stand alone or BMS connected
- Easy Installation of Zigbee Sensors

Energy Management System for Rooms

By installing a ceiling motion sensor, wall motion temperature sensor, window/door sensor, and CO₂ sensor in the room, ideal, waste-free air conditioning is achieved.

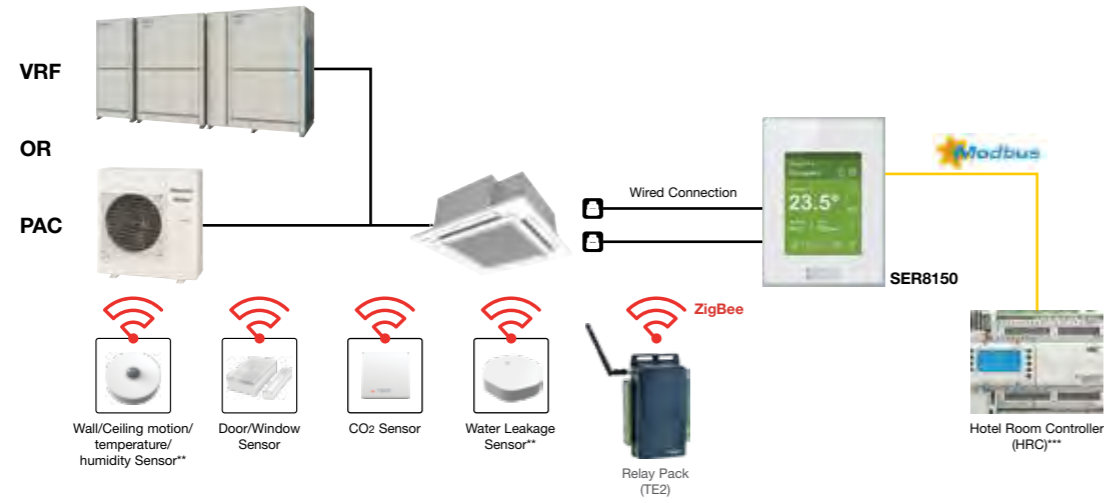







Sensing & Control technology

Using sensors from Schneider Electric, high-quality occupancy control and automatic IAQ control were realised. The sensors detect the presence or absence of occupants, and the opening and closing of doors and windows to achieve the most efficient energy management for exceptional air-conditioned comfort. Flexible installation is possible to match different applications and building features such as walls, ceilings and proximity to doors and windows. No wiring means extra installation versatility.



Batteries last for up to five years (10-year battery for CO₂ sensor) and are easy to install and replace.

 <p>Door/Window Sensor Door and window contact detection sensor to monitor opening and closing.</p>	 <p>Wall/Ceiling motion/temperature/humidity Sensor Wall and ceiling sensor to detect the presence or absence of occupants.</p>	 <p>CO₂ Sensor Monitor indoor air quality, review data on interfacing devices, and control fresh air inside customizable zones.</p>
 <p>Water Leakage Sensor** Two sensing pads under the body activate when water is present between the two pads. Detecting the water, the sensor reports the event to the controller.</p>	 <p>Relay Pack (TE2) Wireless programmable terminal equipment controllers for HVAC equipment and pulse counting. Includes local memory to store fail safe control sequence.</p>	 <p>Hotel Room Controller (HRC)*** The Hotel Room Controller controls connected guest room devices and aggregates data, making it visible to guest room and property management systems.</p>

* Specifications are subject to change without notice.
**Time of release to be confirmed.
***Available through a Schneider Electric distribution channel.

Management System for the Entire Building

The smarter solution to simplify energy management, optimise building efficiency and drive savings.

Plug and Play BMS connection.

With the SER8150, connection to BMS is extremely easy. Better still, a remote controller is all that's needed to enable use as a stand-alone system. In addition to dramatically reducing the burden on system integrators, this cuts costs.

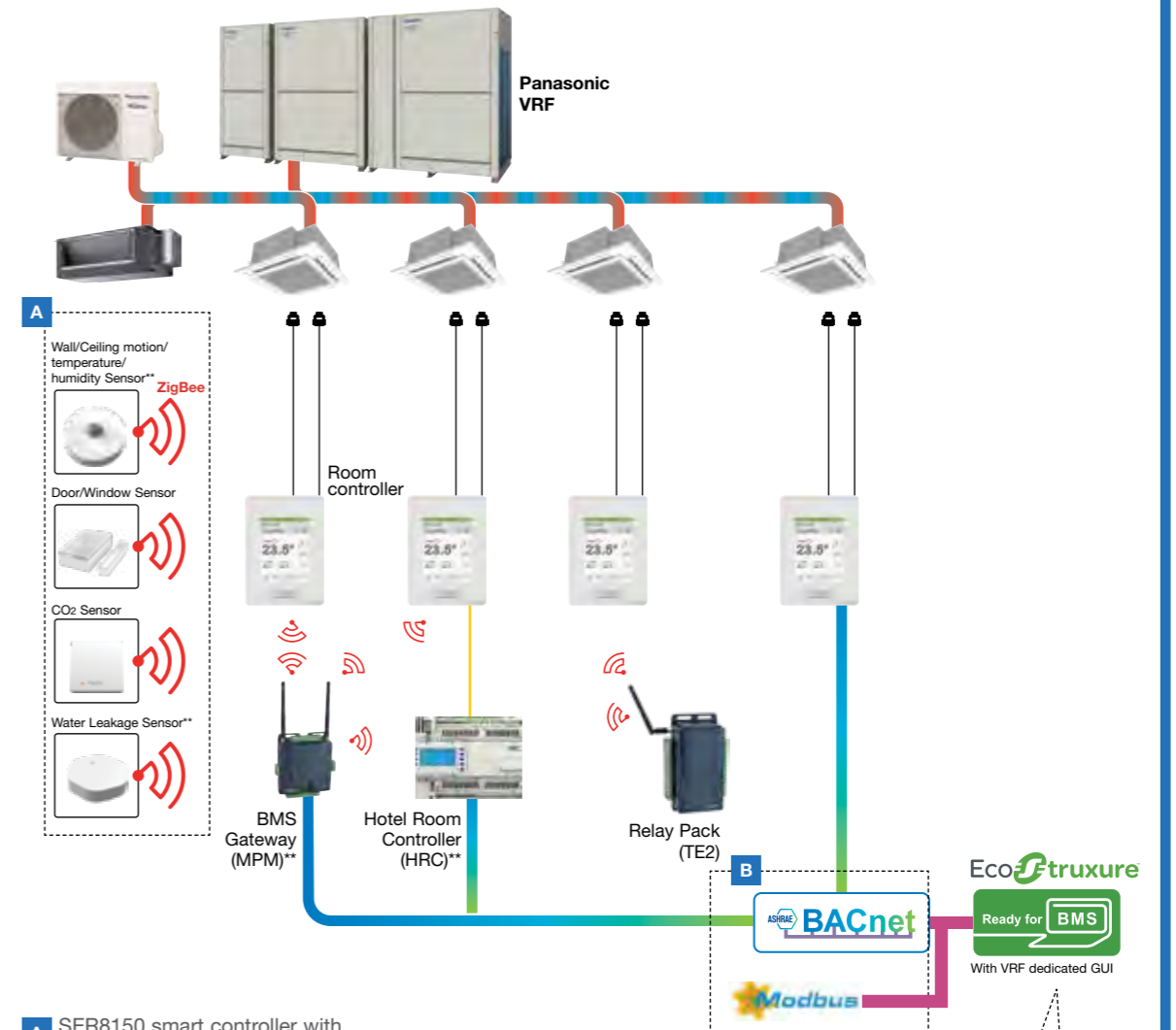

- A** SER8150 smart controller with direct hub to ZigBee® Pro sensors. Great Occupancy and IAQ control. Ex: Hotel room occupancy check by PIR sensor, IAQ by CO₂ sensor, Door / Window contacts.
- B** BACnet MS/TP or Modbus RTU communication are selectable
- C** For Schneider Electric BMS connection, Panasonic VRF widgets enable easy Plug and Play. Better understanding for VRF as a chiller system.



BMS Gateway (MPM)**
Multi-Purpose Management devices enable the control, monitoring, and management of entire sites via Schneider Electric's BMS system.

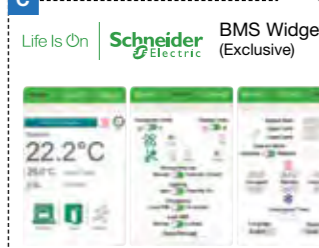

Schneider Electric BMS Widget (Exclusive)
Life Is On Schneider Electric

* Graphic shows combination of products from Panasonic, Schneider Electric and others. Currently, some products might not be available in Australia, please consult authorised dealer for more details.
**Available through a Schneider Electric distribution channel.

Smart Management Solutions

1 Hotels

Room Key Card or Key Cardless Solutions for Hotels

The SER8150 and ZigBee Sensor automatic detection function offer optimal air conditioning regardless of whether there is a hotel room key or not. Sensors detect the presence or absence of occupants and the opening and closing of doors and windows for the optimum air-conditioned environment guests expect. Automatic control ensures the most efficient operation when guests are away or when windows are open. This contributes to an appreciable reduction in operation costs.



1. Remote sensing & IAQ control

In addition to detecting a room's temperature, humidity and CO2 concentration, ZigBee remote sensors detect the opening/closing of windows and doors, and the presence/absence of people in a room. Various IAQ controls and detailed energy savings are possible by using TE2 (Relay Pack) based on this detected information.

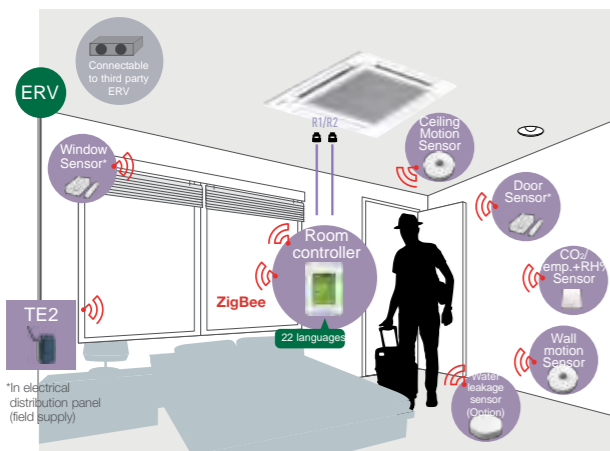

2. BMS Connectivity

With MPM as the BMS gateway and by setting HRC* as the guestroom controller, sensing, control and BMS connection can be realized in coordination with SER8150!

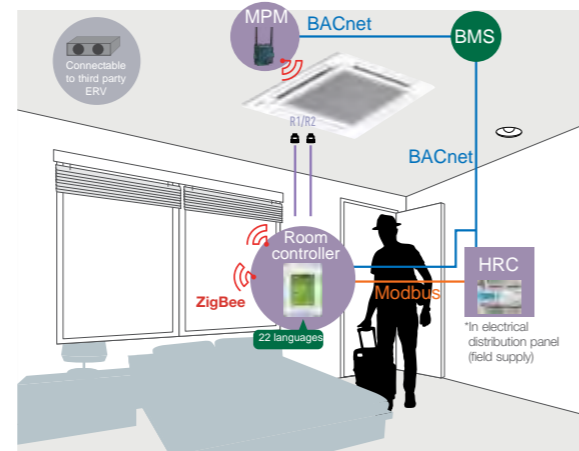

3. Key Cardless control

The introduction of TE2 and HRC* enables conventional wired keycards to be connected to the system so that it is possible to meet the specific requirements of various hotel and room types.

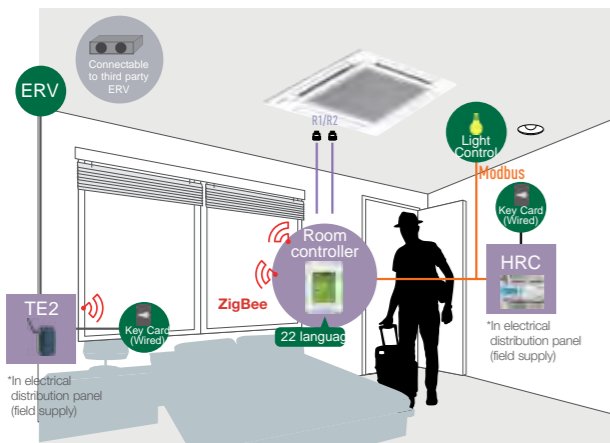

4. Other control

The introduction of TE2, HRC* and MPM* enables the on/off control of devices having dry contact input, such as ventilation, lighting and blinds.

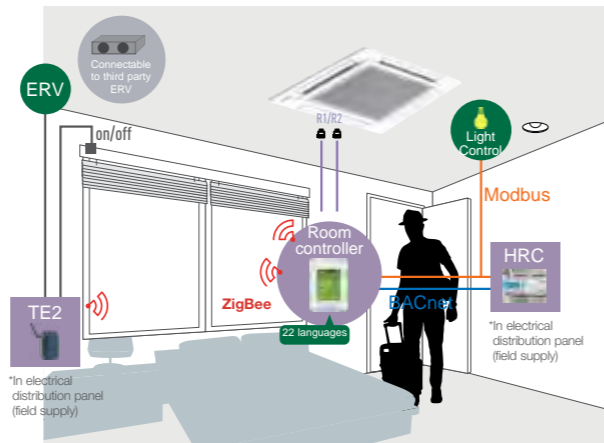

*Available through a Schneider Electric distribution channel.

2 Small and Medium Offices



CO2 sensors (option) and Humidity sensors

CO2 sensors (option) take measurements in units of ppm, and humidity sensors enable fine air quality control. This creates the most comfortable space for occupants while contributing to improved employee satisfaction.

3 Super Markets



Humidity sensors

Humidity sensors enable automatic dehumidification for the optimum IAQ regardless of climatic conditions. This creates an even more comfortable environment for customers, employees, and products themselves.

* Except for products for small sized project (Ultra Slim Ducted, 4-WAY Mini Cassette)

Innovative and Unrivalled Advantages

Colour and Design to Match Office Interiors

Colour combinations and design can be set to match different facilities.



Customisation in 22 Languages Possible

The display can be customised to match the native languages of guests to enable smooth, stress-free communication for hospitality at its finest.



Easy-to-Understand Error Description

Error description during an emergency is easy to understand, enabling staff to respond quickly.



Programmable Logic

Full customisation of remote control logic possible, and updating to match conditions.

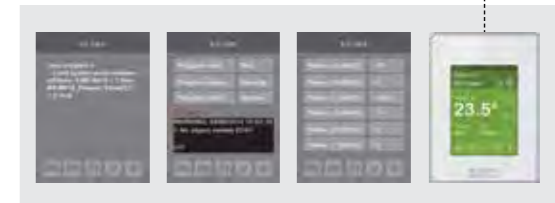

Smart Connectivity Devices

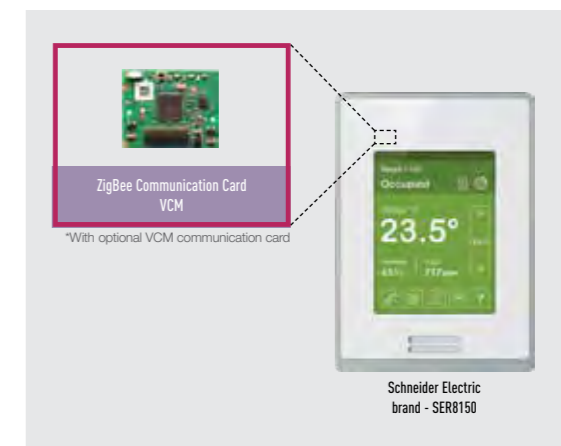

Features

- Up to 5-year battery life batteries included (CO2 sensor is 10 years)
- Battery level is a point
- Sensor points visible when SER8150 is integrated via BACnet MS/TP
- Sensor status and battery level visible when SER8150 is integrated via ZigBee® Pro
- Integration to BMS only recommended when each MPM** is connected to Ethernet and set as a ZigBee® Coordinator node

**Availability and time of release are to be determined.

Reference	Description
SER8150R0B1194	Pana Net Con, RH, No PIR, SE Brand, R1R2
SER8150R5B1194	Pana Net Con, RH, PIR, SE Brand, R1R2
VCM8000V5094P	Wireless ZigBee Pro communication card
TE2	
SEC-TEA-R-230-5045	Smart Terminal Controller ZigBee Pro High Power, External Antenna, 4U/4AO/500, 220-240VAC
SEC-TEA-R-24-5045	Smart Terminal Controller ZigBee Pro High Power, External Antenna, 4U/4AO/500, 24VAC
MPM**	
MPM-UN-014-5045	Universal network controller with Building Expert and StruXureWare integration, High Power, 6 I/O, Modbus
MPM-RAEC-5045	Universal network controller Cable extension

Reference	Description
HRC**	
HRCEP14R	Hotel Room Expansion Module 14IO
HRCPC628R	Hotel Room Controller 28IO
HRCPC642R	Hotel Room Controller w/Display 42IO
ZigBee Sensors	
SED-CO2-G-5045	Sensor with Room CO2, Temperature and Humidity
SED-TRH-G-5045	Sensor with Room Temperature and Humidity
SED-WDC-G-5045	Door/Window Sensor
SED-MTH-G-5045	Wall/Ceiling motion/temperature/humidity Sensor
SED-WLS-G-5045	Water Leakage Sensor

PAC Smart Connectivity+ controller external dimensions

Room Controller for SER8150

Dimensions

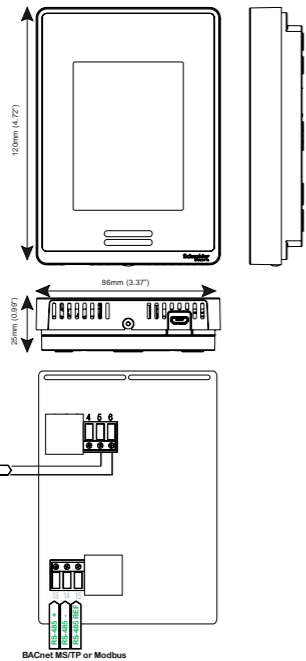

Specifications

Dimensions
 Height: 12cm/4.72in
 Width: 8.6cm/3.39in
 Depth: 2.7cm/1.06in

Power Requirements
 16 Vdc from Panasonic R-R IDU connectors
 50/60 Hz, 4VA, Class 2 Supply

Range from Indoor Unit
 Recommended 500ft (150 m)

Operating Conditions
 0 °C to 50°C (32°F to 122°F)
 0% to 95% R.H. non-condensing

Storage Conditions
 -30°C to 50°C (-22°F to 122°F)
 0% to 95% R.H. non-condensing

Temperature Sensor
 Local 10 K NTC type 2 thermistor

Temperature Sensor Resolution
 ± 0.1°C (± 0.2°F)

Temperature Sensor Accuracy
 ± 0.5°C (± 0.9°F) @ 21°C (70°F) typical calibrated

Humidity Sensor and Calibration
 Single point calibrated bulk polymer type sensor

Humidity Sensor Precision
 Reading range from 10 to 90 % R.H. non-condensing 10 to 20% precision; 10% 20% to 80% precision; 5% 80% to 90% precision; 10% Humidity Sensor Stability
 Less than 1.0 % yearly (typical drift)

Wiring
 Maximum wire length between last indoor unit to SER8150RxB1194 equals 490ft (150m) with AWG #18 wire (0.82 mm²). Refer to Panasonic VRF guidelines "Wiring System Diagram for Remote Controller" for this limitation.

Approximate Shipping Weight
 0.34 kg (0.75 lb)

Check with your local government for instruction on disposal of these products.

THIS PRODUCT FOR COMMERCIAL USE ONLY

Water Leakage Sensor

Dimensions

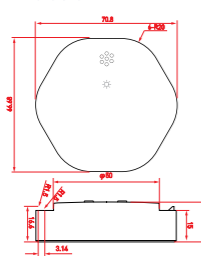

Specifications

Dimensions
 70.8mmx66.7mmx19mm

Colour
 White

Weight
 64g

Communication
 ZigBee 3.0 HA

Battery Voltage
 3V

Battery Cell
 LR03 AAA (2pcs)

Battery Life
 Up to 5 years

Rated Power
 90 mW

Maximum Transmitted Power
 5 dBm

Ambient Temperature
 -10° - +50°C

Frequency Band
 2405-2480 MHz

Certification

Check with your local government for instruction on disposal of these products.

Wall/Ceiling Wireless Sensor SED-MTH-G-5045

Dimensions

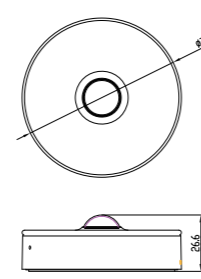

Specifications

Dimensions
 70mm diam. x 26.6mm

Colour
 White

Weight
 59g

Communication
 ZigBee 3.0 HA

Detection Range
 Ceiling: 0.4m (installation height 2.5m)
 Wall: 0.5m (installation height 1.2m)

Battery Voltage
 3V

Battery Cell
 LR03 AAA (2pcs)

Battery Life
 Up to 5 years

Ambient Temperature
 -10° - +50°C

Certification

Check with your local government for instruction on disposal of these products.

Door/Window Wireless Sensor SED-WDC-G-5045

Dimensions

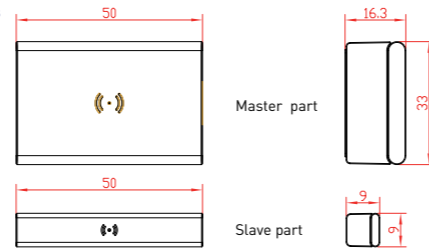

Specifications

Dimensions
 Master part: 50mmx33mmx16.3mm Slave part: 50mmx9mmx9mm

Colour
 White/transp.

Weight
 30g

Communication
 ZigBee 3.0 HA

Detection Range
 Trigger "close": wood 30mm, metal 18mm
 Trigger "open": wood 32mm, metal 20mm

Battery Voltage
 3V

Battery Cell
 CR2450

Battery Life
 Up to 5 years

Ambient Temperature
 -10° - +50°C

Certification

Check with your local government for instruction on disposal of these products.

CO2 Sensor SED-CO2-G-5045

Dimensions

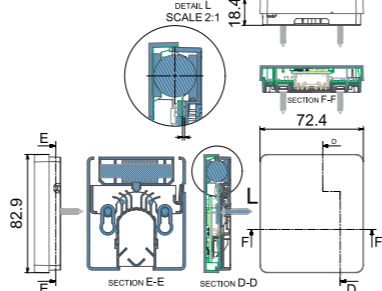

Specifications

Dimensions
 3.26in x 2.85in x 0.72in
 82.9 mm x 72.4 mm x 18.4 mm

Operating Temperature
 0°C to 50°C (32°F to 122°F)

Temperature Accuracy
 ±0.3°C (0.54 °F) typical within operating range

Humidity Range
 0% to 100%

Humidity Accuracy
 ± 3% RH (typical within 0% to 80% RH)

Measurement Range
 0 to 5000 ppm

Measurement/Transmission Intervals
 2.5 minutes (day), 10 minutes (evening)
 Note: Battery life will be reduced should interval be shortened (i.e. using remote temperature/humidity functions)

CO2 Accuracy at NTP
 ±60ppm +3% of reading (400 - 2,000ppm range)

Communication
 ZigBee 3.0 Green Power (encrypted, bi-directional)

Battery Voltage
 3.6 V

Battery Cell
 AA Lithium ion

Battery Life
 10+ years (non-replaceable)
 Note: Battery life can be reduced when sensor is operated at temperatures approaching the operating limits.

Ambient Temperature
 -30°C to 70°C

Certification

Check with your local government for instruction on disposal of these products.

Relay Pack TE2

Dimensions

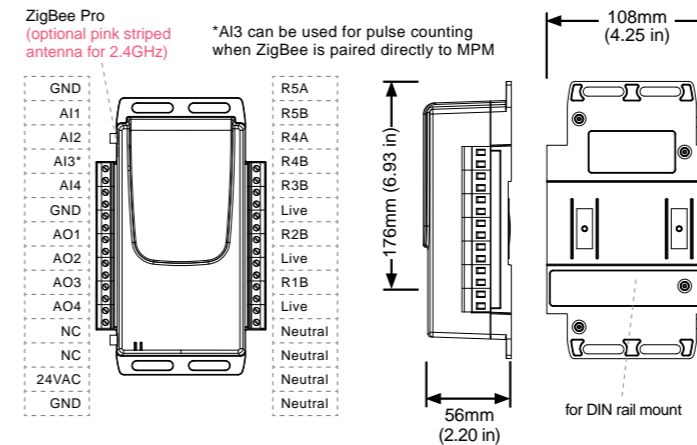

Specifications

Dimensions
 6.93in x 4.25in
 176mm x 108mm

Voltage
 24VAC; ± 15%; 50/60Hz; Class 2.
 24VDC ± 10%
 115VAC/230VAC
 10VA (115/230 VAC)
 5VA (24V)

Typical Consumption
 115VAC/230VAC
 10VA (115/230 VAC)
 5VA (24V)

Inputs
 Pulse input: Support for one fast pulse input counting (up to 1000Hz / 1ms) - AI3
 Analog (x4): 0-12V, nominal 50 mA max each, 12-bit resolution
 Relay (x5) optional: Maximum 230VAC, 5A per relay. First three relays (R1, R2 and R3) or based on input power voltage (24V, 115VAC or 230VAC). Two relays (R4 and R5) are independent of the input power voltage

Outputs
 Analog (x1): 24VAC, 2VA (115 VAC and 230 VAC Voltage only models, one additional output) [20VAC if used with 110V 50Hz]
 Frequency: 2400 to 2483.5MHz, 16RF channels
 Non line of sight to MPM: 50ft/17m
 Line of sight to MPM: 100ft/30m

ZigBee Pro Range

Certification

Check with your local government for instruction on disposal of these products.

Hotel Room Controller HRC**

Dimensions

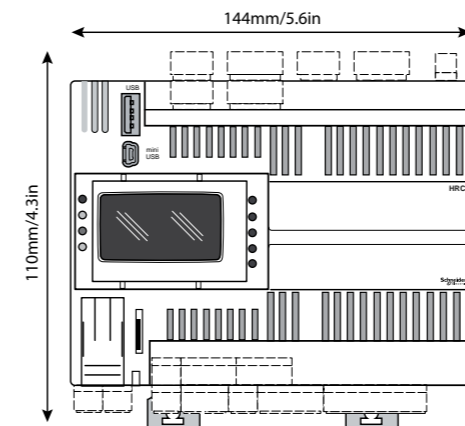

Specifications

Dimensions
 5.6in x 4.3in x 2.4in
 144mm x 110mm x 60.5mm

Digital Inputs
 12

High Voltage Relay
 10 x 3 A SPST +250 VAC relays

Digital Outputs
 12 x configurable analog inputs
 DI: voltage free DI, 10 kΩ input impedance
 0-20mA; range 0..1000, < 150 Ω impedance
 0-10V; range 0..1000 > 10 kΩ impedance

Analog Outputs
 6 x 0-10 V outputs. Load impedance > 700 Ω

Supply Voltage
 24 VAC ± 10% NOT ISOLATED
 +20..38 Vdc NOT ISOLATED

Power Cycle
 50/60 Hz

Operating Temperature
 -20 to 60 °C (-4 to 140 °F) conforming to UL 60730-1

Storage Temperature
 -30 to 70 °C (-22 to 158 °F)

Certification

Check with your local government for instruction on disposal of these products.

BEMS Gateway MPM**

Dimensions

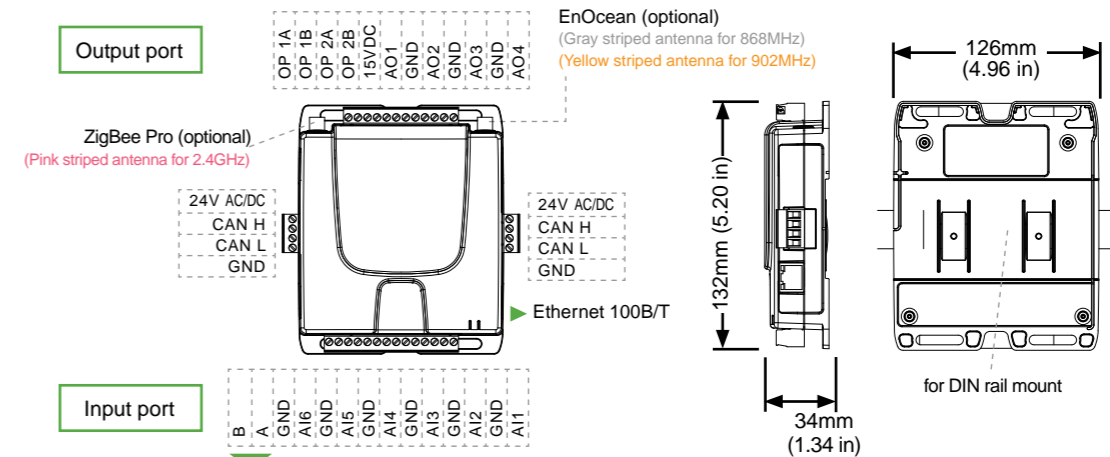

Specifications

Dimensions
 5.20in x 4.96in
 132mm x 126mm

Voltage
 24VAC; ± 15%; 50/60Hz
 24VDC ± 10%

Typical Consumption
 5 VA + Output (VAC), 1.6 W + Output (VDC)

Communication
 ZigBee Pro, EnOcean, BACnet
 CANbus (125-500 Kbps)
 Ethernet (10/100 Mbps)
 Current: 4-20mA with 249 external resistor
 Voltage: 0-10V

Analog Inputs
 Analog (x4): 0-12V, nominal 50mAmax each, 12-bit resolution

Outputs
 Relay (x2): 24V, 1.1 Amp per relay
 Supported protocols: Modbus
 Frequency: 868MHz, 902MHz

RS485 (optional)
ZigBee Pro (Optional)

Certification

Check with your local government for instruction on disposal of these products.

**Except for products for small sized project (Ultra Slim Ducted, 4-WAY Mini Cassette)
 **Available through a Schneider Electric distribution channel.

***Available through a Schneider Electric distribution channel.
 ****PAC Smart Connectivity+ is not applied for Ultra Slim Ducted and 4-WAY Mini Cassette.

Panasonic AC Smart Cloud

With Panasonic AC Smart Cloud, have your business under control, and start saving!



Flexible and scalable solution

- Energy saving
- Zero downtime
- Site(s) management

Centralise control of your business premises, from wherever you are, 24/7/365. It doesn't matter how many sites you have, or where they are! The AC Smart Cloud system from Panasonic allows you to have complete control of all your installations, from your tablet or from your computer. In a simple click, all your units from several locations, receive status updates in real-time of all your installations, preventing breakdowns and optimising costs.

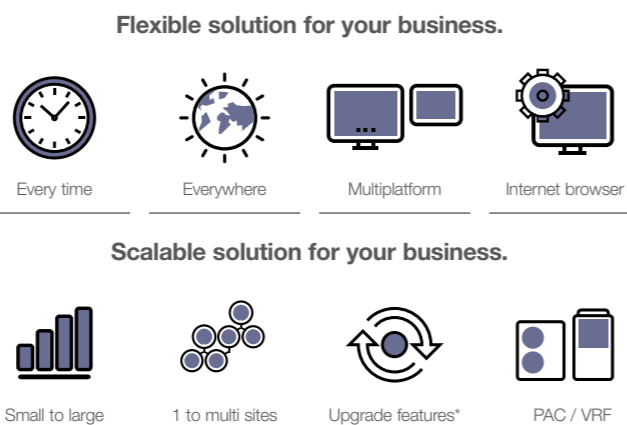

* Customised to meet user demand / Continuous upgrades: new functions and product introductions / IT smart management.

Panasonic AC Smart Cloud offers continuous improvement always thinking about users

New e-CUT function

E-CUT functions are newly available in Panasonic AC Smart Cloud. 5 energy saving settings reduces automatically its energy consumption.

1. Set temperature auto return. When you want to return to the set temperature after a certain time even if the temperature is changed.
2. Unattended auto shut OFF. When you want to operate outside of a schedule but to monitor and stop automatically.
3. Set temperature range limit. When you want to limit the temperatures that can be set.
4. Energy saving timer / Efficient operation setting. Specify time slots when you want operation capacity reduced.
5. Demand / peak shaving settings/ Peak cut settings. Specify time slots when you want operation capacity of the outdoor units reduced.

Key functions and uniqueness

Multi site monitoring.

- It doesn't matter how many sites you have, easy to manage, operate, compare sites, locations, rooms.



Schedule setting.

- Yearly / weekly / holiday timer setting as you want



Powerful statistics for energy savings.

- Power consumption, capacity, efficiency level can be compared with different parameters (Yearly / monthly / weekly / daily bases)



Maintenance notification.

- Error notification by email and with floor layout
- Maintenance notification of PAC / VRF outdoor units
- Remote service checker function



User customisation¹.

Site administrator can create users as desired and assign customised profiles.

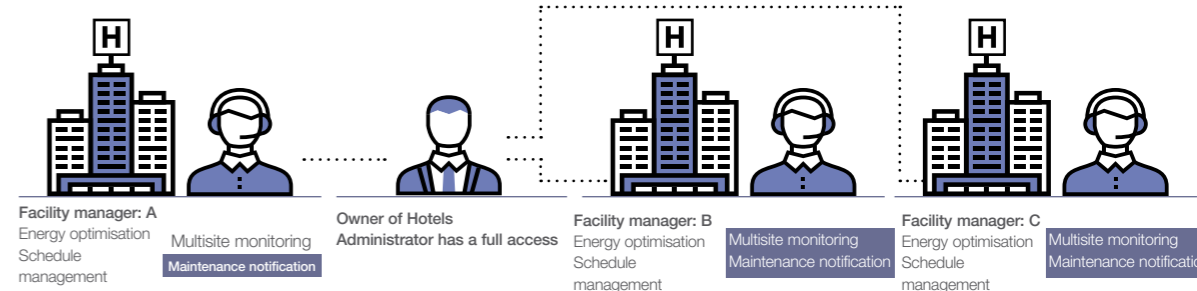

Main functions per user type

Function / Main Tab	Sub-Tab	Basic type (Eg.: Owners, facility managers)	Professional type (Eg.: Installers, maintenance companies)
AC setting	I_U / O_U operation details	✓	✓
	Cloud adapter (CZ-CFUSCC1) details	✓	✓
	AC maintenance	✓	✓
	Map view	✓	✓
Energy saving function	NEW e-CUT	✓	✓
	Schedule	✓	✓
Powerful statistics	Power consumption	✓	✓
	Capacity	✓	✓
	Efficiency ranking	✓	✓

Function / Main Tab	Sub-Tab	Basic type (Eg.: Owners, facility managers)	Professional type (Eg.: Installers, maintenance companies)
Maintenance function	Notification overview / details	✓	✓
	Maintenance settings	✓	✓
	Map view	✓	✓
	Remote service checker	✓	✓
User account ¹	New / update user registration	✓	✓
	Distribution group overview / details	✓	✓
System setting	Cut OFF request	✓	✓
	Map editor	✓	✓

Remote service checker function

Zero down time

- Quick analysis & response
- Time & Cost saving for service maintenance task



Recording service checker parameters from wherever you are!

- Data duration: Maximum 120 minutes
- Data frequency: 10 – 90 seconds
- Mode selection: With test run or Without test run
- Count down schedule setting available

Panasonic AC Smart Cloud parts lists





¹ Cloud service fee is additionally required. Please contact an authorised Panasonic dealer.

CZ-CFUSCC1 AC Smart Cloud communication adaptor. Up to 128 groups. 128 units control











¹ Please contact an authorized Panasonic dealer.

Controllers

A wide variety of control options to meet the requirements of different applications.

OPERATION SYSTEM	INDIVIDUAL CONTROL SYSTEMS			
Requirements	High-spec operation	Normal operation	Operation from anywhere in the room	Normal operation
External appearance				
Type, model name	Deluxe Wired Remote Controller CZ-RTC5B	Timer Remote Controller (Wired) CZ-RTC4	Wireless Remote Controller Controller: CZ-RWS3 Receiver: CZ-RWRU3 CZ-RWRL3 CZ-RWRD3 CZ-RWRT3 CZ-RWRC3	Wired Remote Controller CZ-RD52CP
Built-in thermostat	●	●	—	—
ECONAVI on/off control	●	●	●	—
Number of indoor units which can be controlled	1 group, 8 units	1 group, 8 units	1 group, 8 units	1 unit
Use limitations	• Up to 2 controllers can be connected per group (When using ECONAVI sensor, only one remote controller is possible to connect at indoor unit)	• Up to 2 controllers can be connected per group. (When using ECONAVI sensor, only one remote controller is possible to connect at indoor unit)	• Up to 2 controllers can be connected per group.	• Only 1 controller for 1 indoor unit.
Function ON/OFF	●	●	●	●
Mode setting	●	●	●	●
Fan speed setting	●	●	●	●
Temperature setting	●	●	●	●
Air flow direction	●	●	●	●
Permit/Prohibit switching	—	—	—	—
Weekly program	●	●	—	—

1. Setting is not possible when a remote control unit is present. (Use the remote controller for setting.)
All specifications subject to change without notice.

CENTRALISED CONTROL SYSTEMS			SMART CONTROL SYSTEMS		
Operation with various function from centre station	Only ON/OFF operation from centre station	Simplified load distribution ratio (LDR) for each tenant Touch screen panel	Connection with 3rd Party Controller	Cloud connectivity, operation from anywhere	Schneider Electric room controller
			Seri-Para I/O unit for outdoor unit 		
System Controller CZ-64ESMC3	ON/OFF Controller CZ-ANC3	Intelligent Controller CZ-256ESMC3 (CZ-CFUNC2)		WLAN Smart Adaptor Comfort Cloud App	PAC smart connectivity+
—	—	—	Interface adaptor 	CZ-TACG1 / CZ-CAPWFC1	SER8150 (room controller)
●	—	●		—	●
64 groups, max. 64 units	16 groups, max. 64 units	64 units x 4 links, max. 256 units	Seri-Para I/O unit for each indoor unit 	1 adaptor : 1 group, 8 units. Multiple adaptors for each indoor units : 200 units(10 location x 20 units)	1 group, 8 units
• Up to 10 controllers, can be connected to one system. • Main unit/sub unit (1 main unit + 1 sub unit) connection is possible. • Use without remote controller is possible.	• Up to 8 controllers (4 main units + 4 sub units) can be connected to one system. • Use without remote controller is impossible.	• A communication adaptor (CZ-CFUNC2) must be installed for three or more links.		• Mobile device, free App and internet router is required separately. • Wired remote controller (master) required.	• Comparing to RTC5B, up to 1 controller can be connected per IDU. • Wired to R1/R2. • VRF and PAC(S-link) model only.
●	●	●	Communication Adaptor 	●	●
●	—	●		●	●
●	—	●	LonWorks Interface 	●	●
●	—	●		●	●
●	●	●	CZ-CLNC2 	●	●
●	—	●		—	—

Individual Control Systems

Control contents	Part name, model No.	Quantity
Standard Control <ul style="list-style-type: none"> Control of the various operations of the indoor unit by wired or wireless remote controller. Cooling or heating mode of the outdoor unit is decided by the first priority of the remote controller. 	Wired remoter controller CZ-RTC4 / CZ-RTC5B Wireless remote controller + Receiver CZ-RWS3 (Wall Mounted/ Mini Cassette) CZ-RWS3 + CZ-RWRU3 (4-WAY Cassette) CZ-RWS3 + CZ-RWRT3 (Under Ceiling) CZ-RWS3 + CZ-RWRC3 (All split type)	1 unit each
(1) Group control <ul style="list-style-type: none"> Batch remote control on all indoor units. Operation of all indoor cells in the same mode. Up to 8 units can be connected. The sensor is the body sensor, and thermostat ON/OFF setting in regard to the temperature set by the remote controller is possible for each indoor unit. 	Wired remoter controller CZ-RTC4 / CZ-RTC5B Wireless remote controller + Receiver CZ-RWS3 (Wall Mounted/ Mini Cassette) CZ-RWS3 + CZ-RWRU3 (4-WAY Cassette) CZ-RWS3 + CZ-RWRT3 (Under Ceiling) CZ-RWS3 + CZ-RWRC3 (All split type)	As required
(2) Main/sub remote control <ul style="list-style-type: none"> Max 2 remote controllers per indoor unit. (Main remote controller can be connected) The button pressed last has priority. Timer setting is possible even with the sub remote controller. When using ECONAVI sensor, only one remote controller is possible to connect at indoor unit. 	Main or sub Wired remoter controller CZ-RTC4 / CZ-RTC5B Wireless remote controller + Receiver CZ-RWS3 (Wall Mounted/ Mini Cassette) CZ-RWS3 + CZ-RWRU3 (4-WAY Cassette) CZ-RWS3 + CZ-RWRT3 (Under Ceiling) CZ-RWS3 + CZ-RWRC3 (All split type)	As required

SYSTEM EXAMPLE

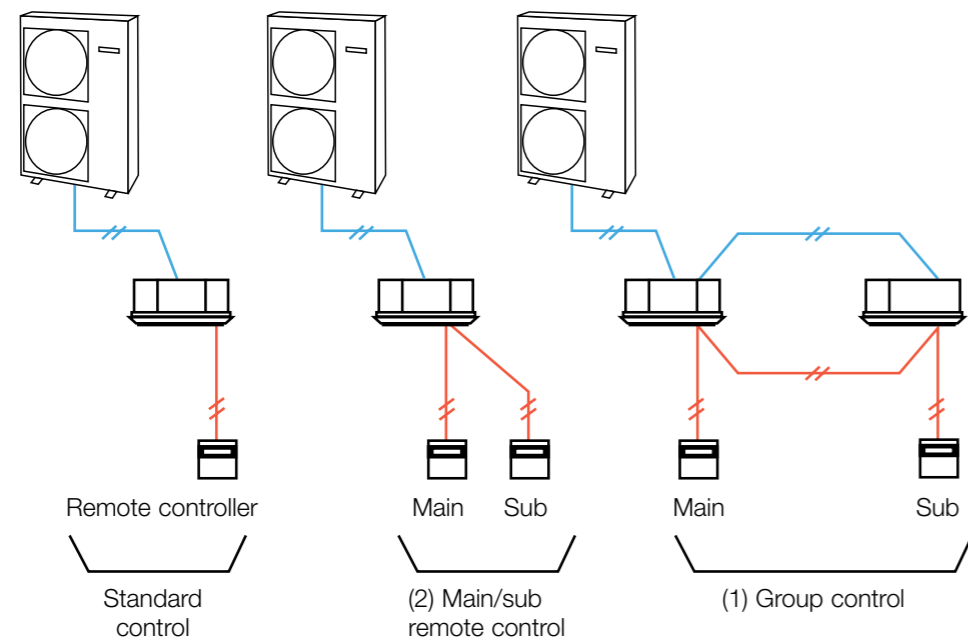

Deluxe wired remote controller (CZ-RTC5B)



Dimensions
H 120 x W 120 x
D 16 mm

Basic Operation

- Individual Louver Control (Lock individual flap for 4-WAY cassette)
- ON/ OFF timer
- Weekly Timer
- Filter information*
- Outing function
- Quiet operation mode*
- Power consumption monitor*
- Energy saving*
- Initial settings
- Ventilation
- nanoeX*

Maintenance Function

- Outdoor unit error data
- Service Contact address
- RC setting mode
- Test Run
- Sensor Information*
- Service check
- Simple/ Detailed Settings
- Auto address

* Subject to the connected model

Energy Saving

- ECONAVI on/ off*
- Temperature Auto Return
- Temperature Setting Range
- Auto Shutoff
- Schedule peak cut
- Repeat off timer

Backup control by using CZ-RTC5B Group wiring of 2 systems of PAC can do auto individual control

- Rotation operation
- Backup operation
- Support operation

Timer remote controller (CZ-RTC4)



Dimensions
H 120 x W 120 x D 20 mm

Weekly Programme Function

- A maximum of 6 settings/day and 42 settings/week can be programmed.

Outing Function

- This function can prevent the room temperature from dropping or rising when the occupants are out for a long time.

Sleeping Function

- This function controls the room temperature for comfortable sleeping.

Maximum 8 indoor units can be controlled from one remote controller

Remote control by main remote controller and sub controller is possible

Maximum 2 remote controllers (main remote controller and sub controller) can be installed for one indoor unit.

* Depending on the model, some menus cannot be used.

Basic remote controller ON/OFF

- Operation mode changeover (Cooling, Heating, Dry, Auto, Fan).
- Temperature setting (Cooling/Dry: 18-30 °C Heating: 16-30 °C).
- Fan speed setting H/ M/ L and Auto.
- Air flow direction adjustment.
- ECONAVI on/ off*

Time Function 24 hours real time clock

- Day of the week indicator.

Wireless remote controller



For 4-WAY Cassette type CZ-RWS3 +CZ-RWRC3

Remote control by main remote controller and sub controller is possible

- Maximum 2 remote controllers (main remote controller and sub controller) can be installed for one indoor unit.

When CZ-RWS3+CZ-RWRC3 is used, wireless control becomes possible for all indoor units

- When a separate receiver is set up in a different room, control from that room also becomes possible.
- Automatic operation by means of the emergency operation button is possible even when the remote controller has been lost or the batteries have been exhausted.

In addition, there are other functions such as temperature setting, operation switching, wind direction/fan speed setting, etc

Ventilation independent operation is possible

When commercial ventilation fans or heat-exchange ventilation fans have been installed, they can be operated with this remote control (interlocked operation with the indoor unit or independent ventilation ON/OFF).



For all Ducted types CZ-RWS3 +CZ-RWRC3



For Under Ceiling type CZ-RWS3 +CZ-RWRT3

Wired remote controller (CZ-RD52CP)



T10 Terminal for External Control (Digital Connection)

Connecting an indoor unit to an external device is easy. The T10 Terminal featured in the electronic circuit board of all indoor units enables digital connection to external devices.



1. T10 Terminal Specification (T10:CN061 at indoor unit PCB)

- Control items: 1. Start/stop input
2. Remote controller prohibit input
3. Start signal output
4. Alarm signal output

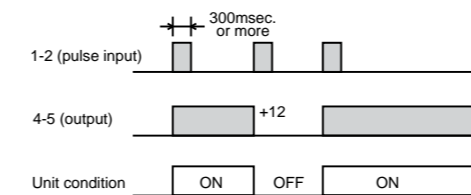

NOTE: The wire length from indoor unit to the Relay must be within 2.0m. Pulse signal changeable to static with JP cutting. (Refer to JP001)

• Example of wiring

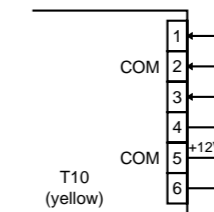

Condition

- 1-2 (Pulse input): Unit ON/OFF condition switching with a pulse signal. (1 pulse signal: shortage status more than 300msec.or more)
- 2-3 (Static input): Open/ Operation with Remote is permitted.(Normal condition) Close/ Remote controller is prohibited.
- 4-5 (Static output): 12V output during the unit ON. / No output at OFF.
- 4-5 (Static output): 12V output when some errors occur / No output at normal.

2. Usage Example

Forced OFF control

• Condition

1-2 (Static input): Close/ Operation with Remote is permitted. (Normal condition) Open/ Unit is forcibly OFF and Remote controller operation is prohibited.

• Example of wiring

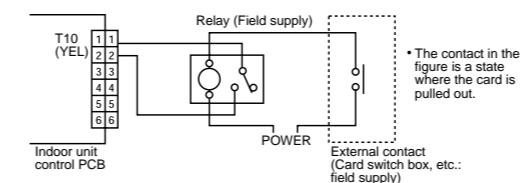

NOTE: The wire length from indoor unit to the Relay must be within 2.0m

Operation ON/OFF signal output

• Condition

4-5 (Static output): 12V output during the unit ON / No output at OFF

• Example of wiring

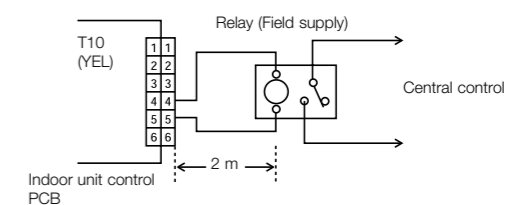

NOTE: The wire length from indoor unit to the Relay must be within 2.0m. Pulse signal changeable to static with JP cutting. (Refer to JP001)

ECONAVI

Reducing inefficient air conditioning

Providing outstanding energy-saving performance, Panasonic's large capacity air conditioners can be connected to ECONAVI to detect when energy is being wasted.

ECONAVI senses the presence or absence of people and the level of activity in each area of a room. When unnecessary heating or cooling is detected, indoor units are individually controlled to match room conditions for energy-saving operation.



ECONAVI Sensor
CZ-CENSC1
Applicable to all 5-types
of indoor units*
* Except 18.0 - 22.4kW models

How 2 sensors work for human detection



Detection of the level of activity enables optimum power saving

Presence or absence of people and the level of activity in the room are detected in real time. Set temperature is automatically adjusted to optimise the power consumption.



Sensors are remotely located to maximise the energy-saving effect

When sensors are built into the indoor unit, pillars, walls, cabinets and other fittings can obstruct the sensors, reducing the area of detection and lowering the energy-saving effect. Panasonic sensors can be located anywhere in the room which enables the optimum layout for sensors in any location.

Case study at coffee shop



In the morning
Reduced cooling when there are fewer people.



In the afternoon
Thorough cooling when there is a high level of activity.



At night
Automatic Thermo Off depending on conditions at the end of the day.

Wide detection area

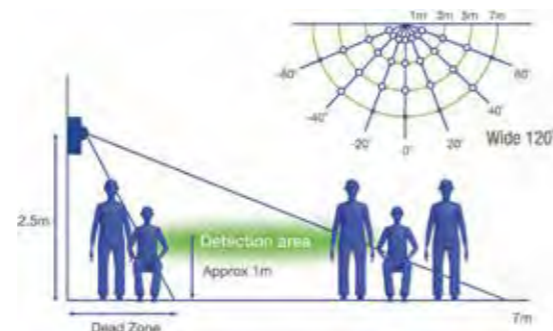

A sensor is remotely set to maximise the detection area.

Installation flexibility for indoor unit layout changes.

Remote Controller External Dimensions

DELUXE WIRED REMOTE CONTROLLER (CZ-RTC5B)

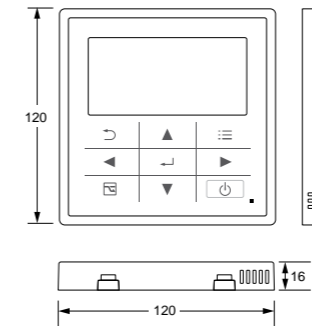

TIMER REMOTE CONTROLLER (CZ-RTC4)

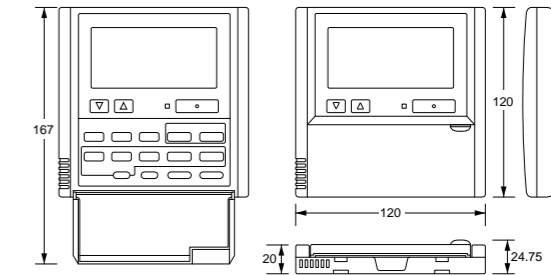

WIRELESS REMOTE CONTROLLER (CZ-RWS3)

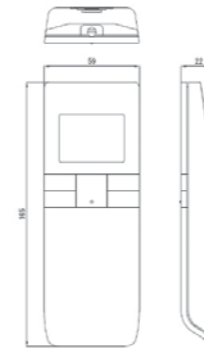

SEPARATE RECEIVER FOR WIRELESS REMOTE CONTROLLER (CZ-RWRC3)

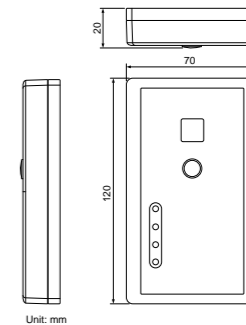

REMOTE SENSOR (CZ-CSRC3)

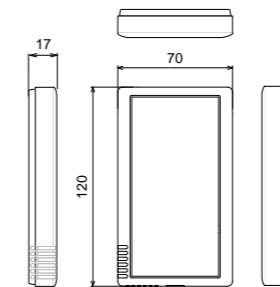

ECONAVI SENSOR (CZ-CENSC1)

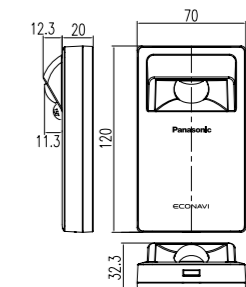

SYSTEM CONTROLLER (CZ-64ESMC3)

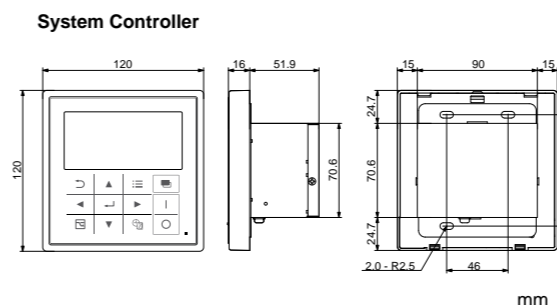

Switch Box

